

ATTENTION!

For Signal-Stat Marker & Clearance products, see addendum on page 585.

MARKER & CLEARANCE LIGHTS

LED LIGHTS

Pages 122-144

SERIES	COMMON SIZE	PAGES
10® Series	2.5"	122-126
12® Series	2" x 3"	126
15® Series	1" x 2"	126-127
18® Series	2" x 5"	128
19® Series	1" x 4"	129-130
21® Series	2" x 6"	130-132
25® Series	2" x 5"	132-133
26 Series	2" x 5"	134
30® Series	2"	134-140
33® Series	0.75"	140-142
35® Series	1" x 4"	143
36 Series	1" x 2"	144

INCANDESCENT LIGHTS

Pages 145-163

SERIES	COMMON SIZE	PAGES
10® Series	2" x 5"	145-146
Super 10® Series	2" x 5"	147
12® Series	2" x 3"	148
13 Series	2" x 4"	149
14 Series	2" x 3"	150
15® Series	1" x 2"	150-151
18® Series	2" x 5"	151
19® Series	1" x 4"	152
21® Series	2" x 6"	153-154
Super 21® Series	2" x 6"	154-156
25® Series	Multiple	156-157
26 Series	Multiple	158-160
30® Series	2"	161-163
60® Series	2" x 6"	163







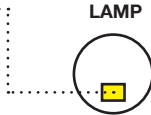
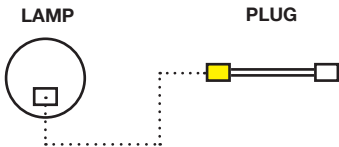
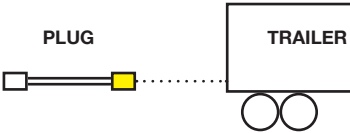



Marker/Clearance Lighting

Truck-Lite's LED marker and clearance lighting is designed to exceed legal requirements when correctly mounted. A variety of styles and mounting options allow for easy customization and provide the safety and visibility that you've come to expect from Truck-Lite.

<p>Shapes</p>	<p>Round, Oval, Rectangular, Triangular, Beehive, Winged</p>
<p>Mount Types</p>	<p>Grommet, Flange, Bracket, 2 Screw, 4 Screw, Adhesive, 2 Bolt, 1 Stud, 2 Stud</p>
<p>Connection Information</p> <p>When it comes to choosing the correct lamps for your truck or trailer, it's important to know the connection type on your vehicle's harness.</p> <p>If the harness connector type does not match your desired light (lamp connector), you will need a plug to complete the connection.</p>	<p>Lamp Connector</p> <p>The connector type located on the back of a lamp</p>  <p>Plug Side 1</p> <p>The connection between a plug and a lamp</p>  <p>Plug Side 2</p> <p>The connection between a plug and a trailer's harness</p> 

(800) 562-5012 | truck-lite.com

 <p>Manufacturing & Quality</p>	 <p>Testing & Safety</p>
<p>Truck-Lite's LED marker/clearance lighting is built using premium materials and backed by industry-leading warranties. Designed to last the life of your vehicle, Truck-Lite's solid-state construction and sealed circuitry mean that you can depend on your lighting to withstand shock, vibration, moisture and debris.</p>	<p>All Truck-Lite lamps are subjected to rigorous environmental, electrical and mechanical testing before they are validated and released to the market.</p> <p>All lamps comply with FMVSS/CMVSS-108, SAE and DOT standards when properly mounted.</p>
 <p>Performance & Maintenance</p>	 <p>Customer Support</p>
<ul style="list-style-type: none"> • Lower energy consumption, allowing more power for other vehicle requirements • Impact-resistant lenses and rugged housing protect against damage from even the toughest applications • Sealed electronics resist damage caused by moisture and corrosion • Reduced lighting costs associated with physical damage and heat entrapment 	<p>Customer Service</p> <p>(800) 562-5012 customerservice@truck-lite.com</p> <p>Technical Support</p> <p>(888) 562-5012 tltech@truck-lite.com</p> <p>Marker & Clearance Warranties</p> <div style="display: flex; justify-content: space-around; align-items: center;">     </div>
<p>(800) 562-5012 truck-lite.com</p>	

10[®] SERIES, LED, GROMMET MOUNT



- Most advanced and cost-effective 2-1/2" clearance and marker lamp
- Completely sealed electronics resist corrosion and moisture
- Less current draw, resulting in increased battery and alternator life while allowing more power for other vehicle requirements
- Polycarbonate lens

Part Number	Lens Color	Lamp Connector	Volts	Amps	Diodes	Lighting Codes	Warranty
10250R	Red	Fit 'N Forget M/C	12	0.03	2	P2, PC	LIFETIME
10250Y	Yellow	Fit 'N Forget M/C	12	0.08	2	P2	LIFETIME
10256R	Red	Fit 'N Forget M/C	12 24	0.05	3	P2, PC	LIFETIME
10256Y	Yellow	Fit 'N Forget M/C	12 24	0.05	3	P2, PC	LIFETIME
10275R	Red	PL-10	12	0.1	8	P2, P3, PC	3-year
10275Y	Yellow	PL-10	12	0.1	8	P2, P3, PC	3-year
10286R	Red	PL-10	12	0.1	8	P2, PC	3-year
10286Y	Yellow	PL-10	12	0.1	8	P2, PC	3-year
10375R	Red	Fit 'N Forget M/C	12	0.1	8	P2, P3, PC	LIFETIME
10375Y	Yellow	Fit 'N Forget M/C	12	0.1	8	P2, P3, PC	LIFETIME
10385R	Red	Fit 'N Forget M/C	12	0.1	8	P2, PC	LIFETIME
10385Y	Yellow	Fit 'N Forget M/C	12	0.1	8	P2, PC	LIFETIME

10[®] SERIES, LED, GROMMET MOUNT, KIT

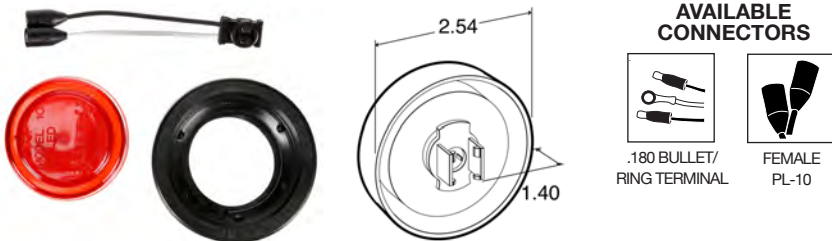

- Most advanced and cost-effective 2-1/2" clearance and marker lamp
- Completely sealed electronics resist corrosion and moisture
- Less current draw, resulting in increased battery and alternator life while allowing more power for other vehicle requirements
- Polycarbonate lens

Part Number	Lens Color	Lamp Connector	Plug Side 1	Plug Side 2	Volts	Amps	Diodes	Lighting Codes	Warranty
10050R	Red	Fit 'N Forget M/C	Fit 'N Forget M/C	Female PL-10	12	0.03	2	P2, PC	LIFETIME
10050Y	Yellow	Fit 'N Forget M/C	Fit 'N Forget M/C	Female PL-10	12	0.08	2	P2, PC	LIFETIME
10075R	Red	PL-10	PL-10	.180 Bullet/Ring Terminal	12	0.1	8	P2, P3, PC	3-year
10075Y	Yellow	PL-10	PL-10	.180 Bullet/Ring Terminal	12	0.1	8	P2, P3, PC	3-year
10076R	Red	Fit 'N Forget M/C	Fit 'N Forget M/C	Female PL-10	12	0.1	8	P2, P3, PC	LIFETIME
10076Y	Yellow	Fit 'N Forget M/C	Fit 'N Forget M/C	Female PL-10	12	0.1	8	P2, P3, PC	LIFETIME
10085R	Red	Fit 'N Forget M/C	Fit 'N Forget M/C	Female PL-10	12	0.1	8	P2, P3, PC	LIFETIME
10085Y	Yellow	Fit 'N Forget M/C	Fit 'N Forget M/C	Female PL-10	12	0.1	8	P2, P3, PC	LIFETIME
10086R	Red	PL-10	PL-10	.180 Bullet/Ring Terminal	12	0.1	8	P2, PC	3-year
10086Y	Yellow	PL-10	PL-10	.180 Bullet/Ring Terminal	12	0.1	8	P2, PC	3-year

10[®] SERIES, LED, ROUND, FLANGE MOUNT

- Most advanced and cost effective 2-1/2" clearance and marker lamp
- Completely sealed electronics resist corrosion and moisture
- Less current draw, resulting in increased battery and alternator life while allowing more power for other vehicle requirements
- Electronics completely sealed in epoxy to resist corrosion and moisture
- Polycarbonate lens

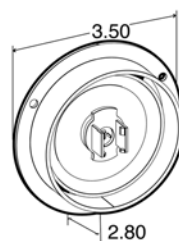

Part Number	Lens Color	Mount Color	Lamp Connector	Volts	Amps	Diodes	Lighting Codes	Warranty
10251R	Red	Gray	Fit 'N Forget M/C	12	0.03	2	P2, PC	LIFETIME
10251Y	Yellow	Gray	Fit 'N Forget M/C	12	0.08	2	P2, PC	LIFETIME
10271Y	Yellow	Gray	Fit 'N Forget M/C	12	0.08	2	P2, PC	LIFETIME
10279R	Red	Gray	PL-10	12	0.1	8	P2, P3, PC	3-year
10279Y	Yellow	Gray	PL-10	12	0.1	8	P2, P3, PC	3-year
10379R	Red	Gray	Fit 'N Forget M/C	12	0.1	8	P2, P3, PC	LIFETIME
10379Y	Yellow	Gray	Fit 'N Forget M/C	12	0.1	8	P2, P3, PC	LIFETIME

10[®] SERIES, LED, ROUND, FLANGE MOUNT, KIT



- Most advanced and cost-effective 2-1/2" clearance and marker lamp
- Completely sealed electronics resist corrosion and moisture
- Polycarbonate lens

AVAILABLE CONNECTORS



.180 BULLET/
RING TERMINAL



FEMALE
PL-10

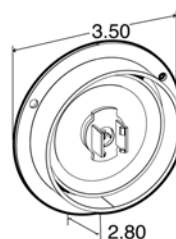

Part Number	Lens Color	Mount Color	Lamp Connector	Plug Side 1	Plug Side 2	Volts	Amps	Diodes	Lighting Codes	Warranty
10051R	Red	Gray	Fit 'N Forget M/C	Fit 'N Forget M/C	Female PL-10	12	0.03	2	P2, PC	LIFETIME
10051Y	Yellow	Gray	Fit 'N Forget M/C	Fit 'N Forget M/C	Female PL-10	12	0.08	2	P2, PC	LIFETIME
10079R	Red	Gray	PL-10	PL-10	.180 Bullet/ Ring Terminal	12	0.1	8	P2, P3, PC	3-year
10079Y	Yellow	Gray	PL-10	PL-10	.180 Bullet/ Ring Terminal	12	0.1	8	P2, P3, PC	3-year
10089R	Red	Gray	PL-10	PL-10	.180 Bullet/ Ring Terminal	12	0.1	8	P2, PC	3-year
10090R	Red	Gray	Fit 'N Forget M/C	Fit 'N Forget M/C	Female PL-10	12	0.1	8	P2, P3, PC	LIFETIME
10090Y	Yellow	Gray	Fit 'N Forget M/C	Fit 'N Forget M/C	Female PL-10	12	0.1	8	P2, P3, PC	LIFETIME
10289R	Red	Gray	PL-10	PL-10	.180 Bullet/ Ring Terminal	12	0.1	8	P2, PC	3-year

PARTS INCLUDED IN KITS ABOVE

KIT #	Included Parts
10051R	10251r light, 93745 plug
10051Y	10251y light, 93745 plug
10079R	10279r light, 94964 plug

KIT #	Included Parts
10079Y	10279y light, 94964 plug
10089R	10289r light, 94964 plug
10090R	10379r light, 93745 plug

KIT #	Included Parts
10090Y	10379y light, 93745 plug

10[®] SERIES, LED, ROUND, FLUSH MOUNT

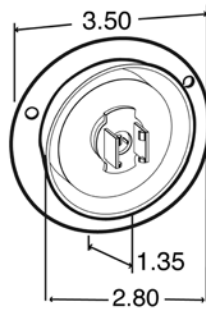

- Most advanced and cost-effective 2-1/2" clearance and marker lamp
- Completely sealed electronics resist corrosion and moisture
- Less current draw, resulting in increased battery and alternator life while allowing more power for other vehicle requirements
- Electronics completely sealed in epoxy to resist corrosion and moisture
- Polycarbonate lens

Part Number	Lens Color	Mount Color	Lamp Connector	Volts	Amps	Diodes	Lighting Codes	Warranty
10288Y	Yellow	Black	PL-10	12	0.1	8	P2, PC	3-year
10289Y	Yellow	Gray	PL-10	12	0.1	8	P2, PC	3-year
10389R	Red	Gray	Fit 'N Forget M/C	12	0.1	8	P2, PC	LIFETIME
10389Y	Yellow	Gray	Fit 'N Forget M/C	12	0.1	8	P2, PC	LIFETIME
10391R	Red	Black	Fit 'N Forget M/C	12	0.1	8	P2, PC	LIFETIME
10391Y	Yellow	Black	Fit 'N Forget M/C	12	0.1	8	P2, PC	LIFETIME

Looking for even more product information?

Visit truck-lite.com



**Powerful Search
Function**



**360° Product
Images**



**Easy-To-Find
Replacement
Parts**

10[®] SERIES, LED, ROUND, FLUSH MOUNT, KIT



- Most advanced and cost-effective 2-1/2" clearance and marker lamp
- Completely sealed electronics resist corrosion and moisture
- Less current draw, resulting in increased battery and alternator life while allowing more power for other vehicle requirements
- Electronics completely sealed in epoxy to resist corrosion and moisture
- Polycarbonate lens

AVAILABLE CONNECTORS



.180 BULLET/
RING TERMINAL



FEMALE
PL-10

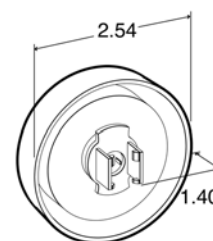

Part Number	Lens Color	Mount Color	Lamp Connector	Plug Side 1	Plug Side 2	Volts	Amps	Diodes	Lighting Codes	Warranty
10089Y	Yellow	Gray	PL-10	PL-10	.180 Bullet/ Ring Terminal	12	0.1	8	P2, PC	3-year
10091R	Red	Gray	Fit 'N Forget M/C	Fit 'N Forget M/C	Female PL-10	12	0.1	8	P2, PC	LIFETIME
10091Y	Yellow	Gray	Fit 'N Forget M/C	Fit 'N Forget M/C	Female PL-10	12	0.1	8	P2, PC	LIFETIME
10092R	Red	Black	Fit 'N Forget M/C	Fit 'N Forget M/C	Female PL-10	12	0.1	8	P2, PC	LIFETIME
10092Y	Yellow	Black	Fit 'N Forget M/C	Fit 'N Forget M/C	Female PL-10	12	0.1	8	P2, PC	LIFETIME
10288R	Red	Black	PL-10	PL-10	.180 Bullet/ Ring Terminal	12	0.1	8	P2, PC	3-year

PARTS INCLUDED IN KITS ABOVE

KIT #	Included Parts
10089Y	10289Y light, 94964 plug
10091R	10389Y light, 93745 plug
10091Y	10389Y light, 93745 plug

KIT #	Included Parts
10092R	10391R light, 93745 plug
10092Y	10391Y light, 93745 plug



Quick Tip: Plug Side 1 vs. Plug Side 2

When buying a plug for your light it's important to understand what type of connection mates with the light and what type of termination will mate with the power harness. Plug Side 1 refers to the side of the plug that mates directly to the light. Plug Side 2 refers to the end of the plug that will mate with the power source.



10[®] SERIES, LED, GROMMET MOUNT, BEEHIVE

LED

10 SERIES



- Popular replacement for cab marker or corner trailer applications
- Meets SAE 592E standards
- Less current draw, resulting in increased battery and alternator life while allowing more power for other vehicle requirements
- LEDs have no filament, therefore are not susceptible to shock and vibration
- Not recommended for use with cam-on mounts
- Polycarbonate lens

Part Number	Lens Color	Lamp Connector	Volts	Amps	Diodes	Lighting Codes	Warranty
10276R	Red	PL-10	12	0.05	8	P2	3-year
10276Y	Yellow	PL-10	12	0.05	8	P2	3-year

12[®] SERIES, LED, GROMMET MOUNT

LED

12 SERIES



- SAE PC-rated for combination clearance/marker applications
- Snap-in lamp makes installation fast and easy
- Lamp gasket #97921 required for proper lamp and bracket fit
- Polycarbonate lens

Part Number	Lens Color	Lamp Connector	Volts	Amps	Diodes	Lighting Codes	Warranty
12275R	Red	PL-10	12	0.12	6	P2, PC	3 year
12275Y	Yellow	PL-10	12	0.12	6	P2, PC	3 year

15[®] SERIES, LED, BRACKET MOUNT

LED

15 SERIES

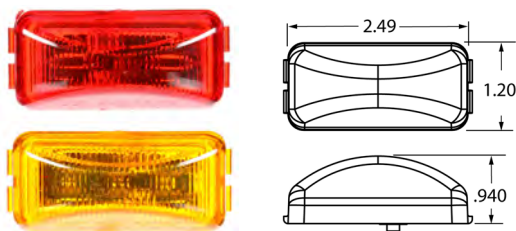

- Designed to fit applications requiring minimal space
- Less susceptible to shock and vibration
- Uses standard mounting holes and accessories
- Not suitable for PC applications
- Draws less current, allowing more power for other vehicle requirements
- Direct pin-to-circuit board solders assure vibration-resistant contacts
- Polycarbonate lens

Part Number	Lens Color	Lamp Connector	Volts	Amps	Diodes	Lighting Codes	Warranty
15250R	Red	PL-10	12	0.05	1	P2, P3	3 year
15250Y	Yellow	PL-10	12	0.05	3	P2, P3	3 year

15[®] SERIES, LED, BRACKET MOUNT, KIT



- Sure contact, self-grounding feature
- Submersible for marine use
- Polycarbonate lens

AVAILABLE CONNECTORS

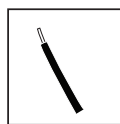

STRIPPED END

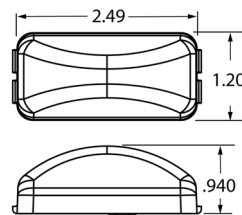

Part Number	Lens Color	Mount Color	Lamp Connector	Plug Side 1	Plug Side 2	Volts	Amps	Diodes	Lighting Codes	Warranty
15033R	Red	Chrome	.156 Bullet Hot Wire	.156 Bullet Hot Wire	Stripped End	12	0.05	1	P2, PC	3 year
15033Y	Yellow	Chrome	.156 Bullet Hot Wire	.156 Bullet Hot Wire	Stripped End	12	0.05	3	P2, PC	3 year

PARTS INCLUDED IN KITS ABOVE

KIT #	Included Parts
15033R	15250R light, 793 bracket, 96904 wire
15033Y	15250Y light, 793 bracket, 96904 wire

15[®] SERIES, LED, BRACKET MOUNT, DUAL FACE, KIT



- Designed for use on most utility trailer fenders
- Wire cover is marked in 1/2" increments for easy length modifications
- Polycarbonate lens

AVAILABLE CONNECTORS

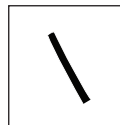

BLUNT CUT

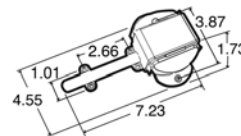

Part Number	Position	Lens Color	Mount Color	Lamp Connector	Plug Side 1	Plug Side 2	Volts	Amps	Diodes	Lighting Codes	Warranty
15417	LH	Red Yellow	Black	PL-10	PL-10	Blunt Cut	12	0.05	4	P2, PC	3 year
15418	RH	Red Yellow	Black	PL-10	PL-10	Blunt Cut	12	0.05	4	P2, PC	3 year

PARTS INCLUDED IN KITS ABOVE

KIT #	Included Parts
15417	15250R light, 15731 bracket mount
15418	15250Y light, 15731 bracket mount

18[®] SERIES, LED, 2 SCREW BRACKET MOUNT, REFLECTORIZED, KIT

LED

18 SERIES

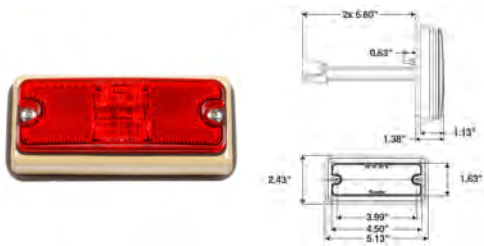

- Complies with SAE J592 and J594 when mounted horizontally
- Brackets utilize standard military color scheme
- Complies with SAE J592 when mounted horizontally between 0 degrees to 34 degrees rollback
- Omnivolt Technology (12 or 24 volt systems will run without adjustment)
- LED life surpasses the 2,000 hours of incandescent bulbs by nearly 50x
- Lens and housing assemblies constructed of impact-resistant polycarbonate
- All electronics fully sealed in epoxy, making lamps less susceptible to shock and vibration
- Faster start-up times and low current draw



Part Number	Lens Color	Mount Color	Lamp Connector	Plug Side 1	Plug Side 2	Volts	Amps	Diodes	Lighting Codes	Warranty
18088R	Red	Tan	Hardwired	Hardwired	Female Military Boot/Ring Terminal	12 24	0.03	3	A P2	1-year
18088Y	Yellow	Tan	Hardwired	Hardwired	Female Military Boot/Ring Terminal	12 24	0.03	3	A P2	1-year
18085R	Red	Green	Hardwired	Hardwired	Female Military Boot/Ring Terminal	12 24	0.05	3	A P2	LIFETIME
18085Y	Yellow	Green	Hardwired	Hardwired	Female Military Boot/Ring Terminal	12 24	0.05	3	A P2	LIFETIME

18[®] SERIES, LED, 2 SCREW, REFLECTORIZED, KIT

LED

18 SERIES

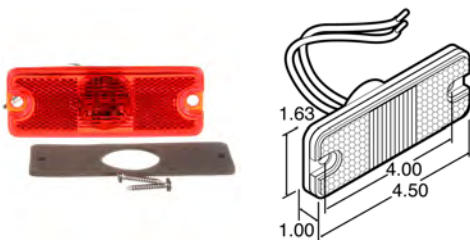

- Uses standard mounting holes and accessories
- Draws less current, allowing more power for other vehicle requirements
- OmniVolt versions also meet ECE standards
- Not suitable for PC requirements
- OmniVolt versions address increasing vehicle power demands by operating equally in electrical systems ranging from 10 to 30 volts
- Meets SAE J592e standards
- Meets SAE J594f when mounted with no rollout or rollback

Part Number	Lens Color	Mount Color	Lamp Connector	Plug Side 1	Plug Side 2	Volts	Amps	Diodes	Lighting Codes	Warranty
18011C	Clear	Clear	Hardwired	Hardwired	Blunt Cut	12 24	0.02	3	E1	3-year
18011R	Red	Red	Hardwired	Hardwired	Blunt Cut	12 24	0.02	3	A P2	3-year
18011Y	Yellow	Yellow	Hardwired	Hardwired	Blunt Cut	12 24	0.02	3	A P2	3-year
18050R	Red	Red	Hardwired	Hardwired	Blunt Cut	12	0.05	3	A P2	3-year
18050Y	Yellow	Yellow	Hardwired	Hardwired	Blunt Cut	12	0.05	3	A P2	3-year
18060R	Red	Red	Hardwired	Hardwired	Packard 12010973	12	0.05	3	A P2	LIFETIME
18060Y	Yellow	Yellow	Hardwired	Hardwired	Packard 12010973	12	0.05	3	A P2	LIFETIME
18070R	Red	Red	Hardwired	Hardwired	Weather 12010972	12	0.05	3	A P2	LIFETIME
18070Y	Yellow	Yellow	Hardwired	Hardwired	Weather 12010972	12	0.05	3	A P2	LIFETIME
18090R	Red	Red	Hardwired	Hardwired	Blunt Cut	12	0.05	3	A P2	3-year
18090Y	Yellow	Yellow	Hardwired	Hardwired	Blunt Cut	12	0.05	3	A P2	3-year

19[®] SERIES, LED, BRACKET MOUNT

- Innovative optic design allows combination lamp to function as two
- Draws less current, allowing more power for other vehicle requirements
- Designed to fit applications requiring minimal space
- Must be mounted horizontally
- PC-rated lamps meets requirements when mounted on a 45 degree angle
- Standard red lamps have 2-diode pattern
- PC-rated red lamps and standard yellow lamps have 4-diode pattern
- PC-rated yellow lamps have 6-diode pattern

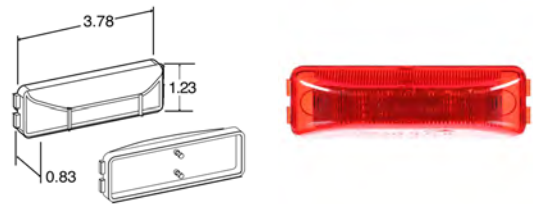

Part Number	Lens Color	Lamp Connector	Volts	Amps	Diodes	Lighting Codes	Warranty
19250R	Red	19 Series Male Pin	12	0.05	2	P2 PC	3-year
19250Y	Yellow	19 Series Male Pin	12	0.05	4	P2 PC	3-year
19251R	Clear Red	19 Series Male Pin	12	0.05	2	P2 PC	3-year
19251Y	Clear Yellow	19 Series Male Pin	12	0.05	6	P2 PC	3-year
19275R	Red	19 Series Male Pin	12	0.05	4	P2 PC	3-year
19275Y	Yellow	19 Series Male Pin	12	0.12	6	P2 PC	3-year
19350R	Red	Fit 'N Forget M/C	12	0.05	2	P2 PC	LIFETIME
19350Y	Yellow	Fit 'N Forget M/C	12	0.05	6	P2 PC	LIFETIME
19375R	Red	Fit 'N Forget M/C	12	0.05	4	P2 PC	LIFETIME
19375Y	Yellow	Fit 'N Forget M/C	12	0.12	6	P2 PC	LIFETIME

19[®] SERIES, LED, BRACKET MOUNT, REFLECTORIZED, KIT



- Popular in trailer and body applications
- Features unique plug-in design for ease of installation
- Must be mounted horizontally
- Low-profile, extra strength base

AVAILABLE CONNECTORS

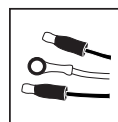

.180 BULLET/
RING TERMINAL

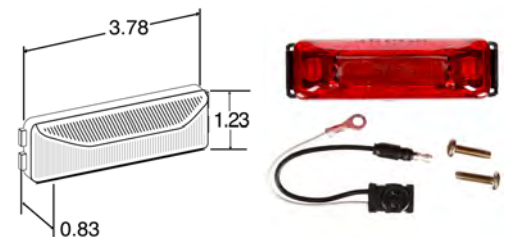

Part Number	Lens Color	Mount Color	Lamp Connector	Plug Side 1	Plug Side 2	Volts	Amps	Diodes	Lighting Codes	Warranty
19031R	Red	Chrome	Fit 'N Forget M/C	Fit 'N Forget M/C	.180 Bullet/ Ring Terminal	12	0.05	2	P2 PC	LIFETIME
19031Y	Yellow	Chrome	Fit 'N Forget M/C	Fit 'N Forget M/C	.180 Bullet/ Ring Terminal	12	0.05	4	P2 PC	LIFETIME
19032R	Red	Black	Fit 'N Forget M/C	Fit 'N Forget M/C	.180 Bullet/ Ring Terminal	12	0.05	2	P2 PC	LIFETIME
19032Y	Yellow	Black	Fit 'N Forget M/C	Fit 'N Forget M/C	.180 Bullet/ Ring Terminal	12	0.05	4	P2 PC	LIFETIME
19036R	Red	Chrome	Fit 'N Forget M/C	Fit 'N Forget M/C	.180 Bullet/ Ring Terminal	12	0.05	4	P2 PC	LIFETIME
19036Y	Yellow	Chrome	Fit 'N Forget M/C	Fit 'N Forget M/C	.180 Bullet/ Ring Terminal	12	0.09	6	P2 PC	LIFETIME
19037R	Red	Black	Fit 'N Forget M/C	Fit 'N Forget M/C	.180 Bullet/ Ring Terminal	12	0.05	4	P2 PC	LIFETIME
19037Y	Yellow	Black	Fit 'N Forget M/C	Fit 'N Forget M/C	.180 Bullet/ Ring Terminal	12	0.09	6	P2 PC	LIFETIME

PARTS INCLUDED IN KITS ABOVE

KIT #	Included Parts
19006R	19250R light, 19721 bracket
19006Y	19250Y light, 19721 bracket
19020R	19275R light, 19721 bracket
19020Y	19275Y light, 19721 bracket

KIT #	Included Parts
19031R	19350R light, 19748 bracket, 94718 plug
19031Y	19350R light, 19748 bracket, 94718 plug
19032R	19350R light, 19728 bracket, 94718 plug
19032Y	19350Y light, 19728 bracket, 94718 plug

19[®] SERIES, LED, BRACKET MOUNT, HARDWIRED, REFLECTORIZED, KIT

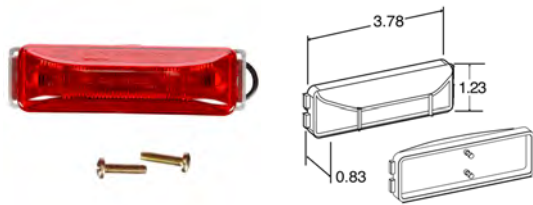

- Innovative optic design allows combination lamp to function as two
- Draws less current, allowing more power for other vehicle requirements
- Designed to fit applications requiring minimal space
- Must be mounted horizontally
- PC-rated lamps meets requirements when mounted on a 45 degree angle
- Standard red lamps have 2-diode pattern
- PC-rated red lamps and standard yellow lamps have 4-diode pattern
- PC-rated yellow lamps have 6-diode pattern

Part Number	Lens Color	Mount Color	Lamp Connector	Plug Side 1	Plug Side 2	Volts	Amps	Diodes	Lighting Codes	Warranty
19006R	Red	Gray	Hardwired	Hardwired	Stripped End	12	0.05	2	P2	3-year
19006Y	Yellow	Gray	Hardwired	Hardwired	Stripped End	12	0.05	4	P2 PC	3-year
19020R	Red	Gray	Hardwired	Hardwired	Stripped End	12	0.1	4	P2 PC	3-year
19020Y	Yellow	Gray	Hardwired	Hardwired	Stripped End	12	0.1	6	P2 PC	3-year

PARTS INCLUDED IN KITS ABOVE

KIT #	Included Parts
19006R	19250R light, 19721 bracket
19006Y	19250Y light, 19721 bracket

KIT #	Included Parts
19020R	19275R light, 19721 bracket
19020Y	19275Y light, 19721 bracket

21[®] SERIES, LED, 2 SCREW

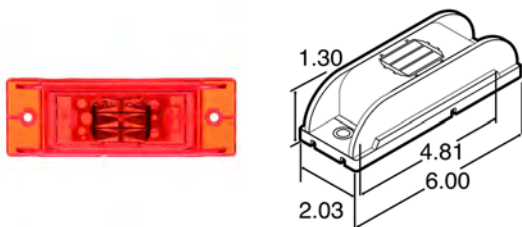

- Innovative optic design allows one PC rated lamp the ability to function as two
- Draws less current, allowing more power for other vehicle requirements
- Uses standard mounting holes and accessories
- Standard lamps have 3-diode pattern
- PC rated lamps have 8-diode pattern

Part Number	Lens Color	Mount Color	Lamp Connector	Volts	Amps	Diodes	Lighting Codes	Warranty
21275R	Red	Red	Fit 'N Forget M/C	12	0.1	8	P2 PC	LIFETIME
21275Y	Yellow	Yellow	Fit 'N Forget M/C	12	0.1	8	P2 PC	LIFETIME

21[®] SERIES, LED, 2 SCREW, HARDWIRED

- Popular replacement on Freightliner vehicles where lamp is not mounted on a curved location
- Electronics completely sealed in epoxy to resist corrosion and moisture
- Less susceptible to shock and vibration
- LED lamps offer superior brightness and faster start time than incandescent versions

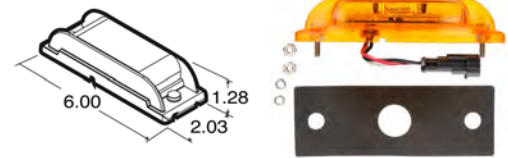

Part Number	Lens Color	Mount Color	Lamp Connector	Plug Side 1	Plug Side 2	Volts	Amps Major/Minor	Diodes	Lighting Codes	Warranty
21093Y	Yellow	Yellow	Hardwired	Hardwired	3 Position Connector	12	0.17/0.03	16	P2 PC	LIFETIME
21090Y	Yellow	Yellow	Hardwired	AMP 282105-1	AMP 282105-1	12	0.17/0.03	16	P2 PC	LIFETIME
21091Y	Yellow	Yellow	Hardwired	AMP 282105-1	AMP 282105-1	12	0.16/0.03	16	P2 PC	LIFETIME
21092Y	Yellow	Yellow	Hardwired	AMP 282105-1	AMP 282105-1	12	0.16/0.03	16	P2 PC	LIFETIME
21094Y	Yellow	Yellow	Hardwired	AMP 282105-1	AMP 282105-1	12	0.16/0.03	16	P2 PC	LIFETIME
21095Y	Yellow	Yellow	Hardwired	AMP 282105-1	AMP 282105-1	12	0.16/0.03	16	P2 PC	LIFETIME
21096Y	Yellow	Yellow	Hardwired	AMP 282105-1	AMP 282105-1	12	0.16/0.03	16	P2 PC	LIFETIME

21[®] SERIES, LED, 2 SCREW, KIT



- Innovative optic design allows one PC rated lamp the ability to function as two
- Draws less current, allowing more power for other vehicle requirements
- Uses standard mounting holes and accessories
- Standard lamps have 3-diode pattern
- PC rated lamps have 8-diode pattern

AVAILABLE CONNECTORS

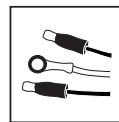

.180 BULLET/
RING TERMINAL

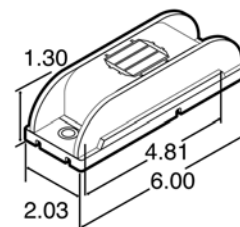

Part Number	Lens Color	Mount Color	Lamp Connector	Plug Side 1	Plug Side 2	Volts	Amps	Diodes	Lighting Codes	Warranty
21075R	Red	Red	Fit 'N Forget M/C	Fit 'N Forget M/C	.180 Bullet/Ring Terminal	12	0.1	8	P2 PC	LIFETIME
21075Y	Yellow	Yellow	Fit 'N Forget M/C	Fit 'N Forget M/C	.180 Bullet/Ring Terminal	12	0.1	8	P2 PC	LIFETIME

PARTS INCLUDED IN KITS ABOVE

KIT #	Included Parts
21075R	21275R light, 94862 plug
21075Y	21275Y light, 94862 plug

21[®] SERIES, LED, 2 SCREW, REFLECTORIZED

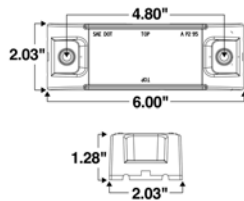

- Innovative optic design allows one PC-rated lamp the ability to function as two
- Draws less current, allowing more power for other vehicle requirements
- Uses standard mounting holes and accessories

Part Number	Lens Color	Mount Color	Lamp Connector	Volts	Amps	Diodes	Lighting Codes	Warranty
21251R	Red	Red	Fit 'N Forget M/C	12	0.1	1	A P2 PC	LIFETIME
21251Y	Yellow	Yellow	Fit 'N Forget M/C	12	0.1	2	A P2 PC	LIFETIME
21256R	Red	Red	Fit 'N Forget M/C	24	0.05	3	A P2 PC	LIFETIME
21256Y	Yellow	Yellow	Fit 'N Forget M/C	24	0.05	3	A P2 PC	LIFETIME
21880R	Red	Red	Fit 'N Forget M/C	12	0.1	1	A P2 PC	LIFETIME
21880Y	Yellow	Yellow	Fit 'N Forget M/C	12	0.1	2	A P2 PC	LIFETIME

21[®] SERIES, LED, 2 SCREW, REFLECTORIZED, KIT

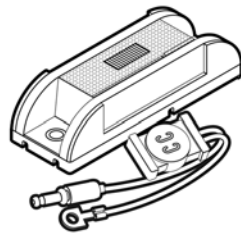

AVAILABLE CONNECTORS

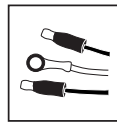

.180 BULLET/
RING TERMINAL

- Innovative optic design allows one PC-rated lamp the ability to function as two
- Draws less current, allowing more power for other vehicle requirements
- Uses standard mounting holes and accessories



Part Number	Lens Color	Mount Color	Lamp Connector	Plug Side 1	Plug Side 2	Volts	Amps	Diodes	Lighting Codes	Warranty
21051R	Red	Red	Fit 'N Forget M/C	Fit 'N Forget M/C	.180 Bullet/ Ring Terminal	12	0.1	1	A P2 PC	LIFETIME
21051Y	Yellow	Yellow	Fit 'N Forget M/C	Fit 'N Forget M/C	.180 Bullet/ Ring Terminal	12	0.1	2	A P2 PC	LIFETIME
21056R	Red	Red	Fit 'N Forget M/C	Fit 'N Forget M/C	.180 Bullet/ Ring Terminal	24	0.05	3	A P2 PC	LIFETIME
21056Y	Yellow	Yellow	Fit 'N Forget M/C	Fit 'N Forget M/C	.180 Bullet/ Ring Terminal	24	0.05	3	A P2 PC	LIFETIME
21080R	Red	Red	Fit 'N Forget M/C	Fit 'N Forget M/C	.180 Bullet/ Ring Terminal	12	0.1	1	A P2 PC	LIFETIME
21080Y	Yellow	Yellow	Fit 'N Forget M/C	Fit 'N Forget M/C	.180 Bullet/ Ring Terminal	12	0.1	2	A P2 PC	LIFETIME

25 SERIES, LED, 2 SCREW, HARDWIRED, KIT

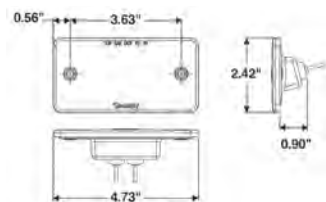

- Hermetically sealed lens and housing
- Electronics completely sealed in epoxy to resist corrosion and moisture
- Less susceptible to shock and vibration
- Draws less current, allowing more power for other vehicle requirements
- Direct pin-to-circuit board solders assure vibration-resistant contacts



Part Number	Lens Color	Mount Color	Lamp Connector	Plug Side 1	Plug Side 2	Volts	Amps	Diodes	Lighting Codes	Warranty
25256Y	Yellow	Yellow	Hardwired	Hardwired	PE Connector	12	0.12	6	P2 PC	1-year

LED

21 SERIES

LED

21 SERIES

LED

25 SERIES

25 SERIES, LED, 2 SCREW

- Feature unique lens design for applications requiring a surface mount combination lamp
- Mounting gasket included to improve seal between lamp and vehicle
- Suitable for PC requirements when mounted on a 45-degree angle

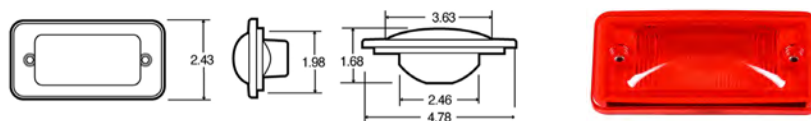

Part Number	Lens Color	Mount Color	Lamp Connector	Volts	Amps	Diodes	Lighting Codes	Warranty
25784R	Red	Red	Socket Assembly	12	0.1	8	P2 PC	1-year
25784Y	Yellow	Yellow	Socket Assembly	12	0.1	8	P2 PC	1-year

25 SERIES, LED, 2 SCREW, HARDWIRED

- 25750Y features hardwired connections with optional field installable butt-splice connectors
- Hermetically sealed lens and housing
- Electronics completely sealed in epoxy to resist corrosion and moisture
- Less susceptible to shock and vibration
- Draws less current, allowing more power for other vehicle requirements
- Direct pin-to-circuit board solders assure vibration resistant contacts
- Includes 97701 mounting gasket with #25250R/Y and 25750Y
- 25750Y is legal when mounted 0 to 40 degree rollback from vertical

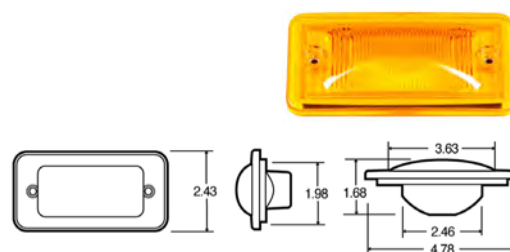

Part Number	Lens Color	Mount Color	Lamp Connector	Plug Side 1	Plug Side 2	Volts	Amps	Diodes	Lighting Codes	Warranty
25250R	Red	Red	Hardwired	Hardwired	Stripped End	12	0.1	3	P2 PC	LIFETIME
25250Y	Yellow	Yellow	Hardwired	Hardwired	Stripped End	12	0.1	3	P2 PC	LIFETIME
25750Y	Yellow	Yellow	Hardwired	Hardwired	Stripped End	12	0.1	3	P2 PC	LIFETIME

Keep Your Connections Safe. Don't Forget Your Dielectric Gel.

Dielectric gel protects your lights by protecting the points of contact between elements of your lighting and harness system. Our dielectric compounds prevent arcing and corrosion and keep your lights performing as they should.

You can find our dielectric products on page 498



26 SERIES, LED, 2 SCREW, HARDWIRED

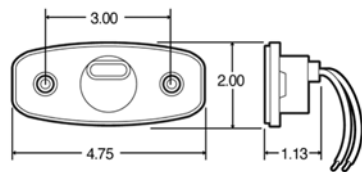

- Popular in trailer and body applications
- Hardwired design with blunt cut or molded bullet ends
- Innovative optics design allows for horizontal or vertical mounting
- Not suitable for PC requirements

Part Number	Lens Color	Mount Color	Lamp Connector	Plug Side 1	Plug Side 2	Volts	Amps	Diodes	Lighting Codes	Warranty
26250R	Red	Red	Hardwired	Hardwired	.180 Bullet	12	0.05	3	P2 PC	LIFETIME
26250Y	Yellow	Yellow	Hardwired	Hardwired	.180 Bullet	12	0.05	3	P2 PC	LIFETIME
26251R	Red	Red	Hardwired	Hardwired	Blunt Cut	12	0.05	3	P2 PC	LIFETIME
26251Y	Yellow	Yellow	Hardwired	Hardwired	Blunt Cut	12	0.05	3	P2 PC	LIFETIME

26 SERIES, LED, 2 SCREW, HARDWIRED, KIT

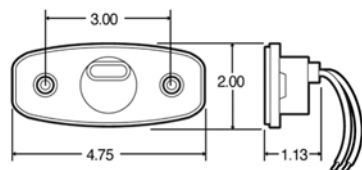

- Unique dome lens design
- Popular in trailer and body applications
- Hard wired design with molded .180 bullet ends
- Innovative optics design allows for horizontal mounting
- LEDs have no filament, therefore are not susceptible to shock and vibration
- Not suitable for PC requirements



Part Number	Lens Color	Mount Color	Lamp Connector	Plug Side 1	Plug Side 2	Volts	Amps	Diodes	Lighting Codes	Warranty
26270R	Red	Red	Hardwired	Hardwired	.180 Bullet	12	0.05	3	P2 PC	LIFETIME
26270Y	Yellow	Yellow	Hardwired	Hardwired	.180 Bullet	12	0.05	3	P2 PC	LIFETIME

30[®] SERIES, LED, FLUSH MOUNT

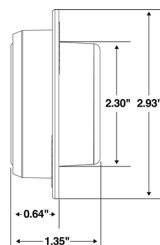

- Low-profile design reduces damage resulting from tree limbs and extruded dock seals

Part Number	Lens Color	Mount Color	Lamp Connector	Volts	Amps	Diodes	Lighting Codes	Warranty
30272R	Red	Gray	Fit 'N Forget M/C	12	0.05	2	P2 P3	LIFETIME
30272Y	Yellow	Gray	Fit 'N Forget M/C	12	0.05	2	P2 P3	LIFETIME

LED

26 SERIES

LED

26 SERIES

LED

30 SERIES

30[®] SERIES, LED, FLUSH MOUNT, KIT



- Flange is permanently affixed to lamp
- Lamp kits include one plug or harness
- Direct pin-to-circuit board solders assure vibration-resistant contacts
- Electronics completely sealed in epoxy to resist corrosion and moisture
- Low current draw, leaving more power for other vehicle requirements
- Sonically sealed lens and housing
- LEDs are less susceptible to shock and vibration
- Lamp flush mounts with a grommet or flange
- Approved to comply with ECE regulations for side marker and end outline marker functions
- OmniVolt universal lighting products address increasing vehicle power demands by operating equally in electrical systems that range from 10 to 30 volts

AVAILABLE CONNECTORS

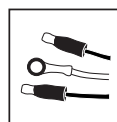

.180 BULLET/
RING TERMINAL

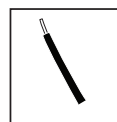

STRIPPED
END



FEMALE
PL-10

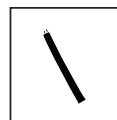

BLUNT
CUT

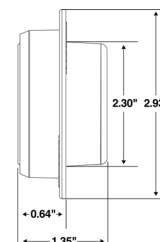

Part Number	Lens Color	Mount Color	Lamp Connector	Plug Side 1	Plug Side 2	Volts	Amps	Diodes	Lighting Codes	Warranty
30051R	Red	Gray	Fit 'N Forget M/C	Fit 'N Forget M/C	Female PL-10	12	0.05	2	P2 P3	LIFETIME
30051Y	Yellow	Gray	Fit 'N Forget M/C	Fit 'N Forget M/C	Female PL-10	12	0.05	2	P2 P3	LIFETIME
30060R	Red	Gray	Fit 'N Forget M/C	Fit 'N Forget M/C	Stripped End	12 24	0.05	3	E1	LIFETIME
30060Y	Yellow	Gray	Fit 'N Forget M/C	Fit 'N Forget M/C	Stripped End	12 24	0.05	3	E1	LIFETIME
30065Y	Yellow	Gray	Fit 'N Forget M/C	Fit 'N Forget M/C	Blunt Cut	12 24	0.05	3	E1	LIFETIME
30066R	Red	Gray	Fit 'N Forget M/C	Fit 'N Forget M/C	Stripped End	12 24	0.05	3	E1	LIFETIME
30066Y	Yellow	Gray	Fit 'N Forget M/C	Fit 'N Forget M/C	Stripped End	12 24	0.05	3	E1	LIFETIME
30071R	Red	Gray	Fit 'N Forget M/C	Fit 'N Forget M/C	Female PL-10	12	0.05	2	P2 P3	LIFETIME
30071Y	Yellow	Gray	Fit 'N Forget M/C	Fit 'N Forget M/C	Female PL-10	12	0.05	2	P2 P3	LIFETIME
30091R	Red	Gray	Fit 'N Forget M/C	Fit 'N Forget M/C	Female PL-10	12	0.12	6	P2 PC	LIFETIME
30091Y	Yellow	Gray	Fit 'N Forget M/C	Fit 'N Forget M/C	Female PL-10	12	0.12	6	P2 PC	LIFETIME

PARTS INCLUDED IN KITS ABOVE

KIT #	Included Parts
30051R	30251R light, 93745 plug
30051Y	30251Y light, 93745 plug
30060R	30251Y light, 93745 plug
30060Y	30265R light, 94781 plug
30065Y	30265Y light, 93745 plug
30066R	30265Y light, 94782 plug
30066Y	30265Y light, 94782 plug
30071R	302272R light, 93745 plug
30071Y	30272Y light, 93745 plug
30091R	30386R light, 93745 plug
30091Y	30386Y light, 93745 plug

30[®] SERIES, LED, FLANGE MOUNT

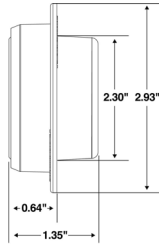

- Flange is permanently affixed to lamp
- Lamp kits include one plug or harness
- Direct pin-to-circuit board solders assure vibration-resistant contacts
- Electronics completely sealed in epoxy to resist corrosion and moisture
- Low current draw, leaving more power for other vehicle requirements
- Sonically sealed lens and housing
- LEDs are less susceptible to shock and vibration
- Lamp flush mounts with a grommet or flange
- Approved to comply with ECE regulations for side marker and end outline marker functions
- OmniVolt universal lighting products address increasing vehicle power demands by operating equally in electrical systems that range from 10 to 30 volts

Part Number	Lens Color	Mount Color	Lamp Connector	Volts	Amps	Diodes	Lighting Codes	Warranty
30251R	Red	Gray	Fit 'N Forget M/C	12	0.05	2	P2 P3	LIFETIME
30251Y	Yellow	Gray	Fit 'N Forget M/C	12	0.05	2	P2 P3	LIFETIME
30262R	Red	Gray	Fit 'N Forget M/C	12 24	0.05	1	E1	LIFETIME
30262Y	Yellow	Gray	Fit 'N Forget M/C	12 24	0.05	1	E1	LIFETIME
30265R	Red	Gray	Fit 'N Forget M/C	12 24	0.05	1	E1	LIFETIME
30265Y	Yellow	Gray	Fit 'N Forget M/C	12 24	0.05	1	E1	LIFETIME
30269Y	Yellow	Gray	PL-10	12	0.1	8	P2 P3 PC	3-year
30271Y	Yellow	Gray	Fit 'N Forget M/C	12	0.05	2	P2 P3	LIFETIME
30279R	Red	Gray	PL-10	12	0.1	8	P2 P3 PC	3-year
30279Y	Yellow	Gray	PL-10	12	0.1	8	P2 P3 PC	3-year
30288R	Red	Black	PL-10	12	0.12	6	P2 PC	3-year
30288Y	Yellow	Black	PL-10	12	0.12	6	P2 PC	3-year
30289R	Red	Gray	PL-10	12	0.12	6	P2 PC	3-year
30289Y	Yellow	Gray	PL-10	12	0.12	6	P2 PC	3-year
30379R	Red	Gray	Fit 'N Forget M/C	12	0.1	8	P2 P3 PC	LIFETIME
30379Y	Yellow	Gray	Fit 'N Forget M/C	12	0.1	8	P2 P3 PC	LIFETIME
30386R	Red	Gray	Fit 'N Forget M/C	12	0.12	6	P2 PC	LIFETIME
30386Y	Yellow	Gray	Fit 'N Forget M/C	12	0.1	6	P2 PC	LIFETIME

30[®] SERIES, LED, FLANGE MOUNT, KIT



- Flange is permanently affixed to lamp
- Lamp kits include one plug or harness
- Direct pin-to-circuit board solders assure vibration-resistant contacts
- Electronics completely sealed in epoxy to resist corrosion and moisture
- Low current draw, leaving more power for other vehicle requirements
- Sonically sealed lens and housing
- LEDs are less susceptible to shock and vibration
- Lamp flush mounts with a grommet or flange
- Approved to comply with ECE regulations for side marker and end outline marker functions
- OmniVolt universal lighting products address increasing vehicle power demands by operating equally in electrical systems that range from 10 to 30 volts

AVAILABLE CONNECTORS

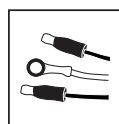

.180 BULLET/
RING TERMINAL

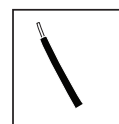

STRIPPED
END

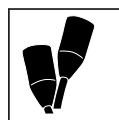

FEMALE
PL-10

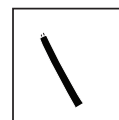

BLUNT
CUT

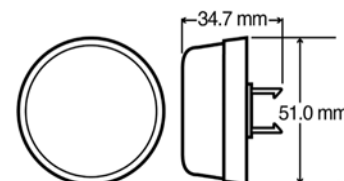

Part Number	Lens Color	Mount Color	Lamp Connector	Plug Side 1	Plug Side 2	Volts	Amps	Diodes	Lighting Codes	Warranty
30061R	Red	Gray	Fit 'N Forget M/C	Fit 'N Forget M/C	Stripped End	12 24	0.05	3	E1	LIFETIME
30061Y	Yellow	Gray	Fit 'N Forget M/C	Fit 'N Forget M/C	Stripped End	12 24	0.05	3	E1	LIFETIME
30062R	Red	Gray	Fit 'N Forget M/C	Fit 'N Forget M/C	Blunt Cut	12 24	0.05	3	E1	LIFETIME
30080R	Red	Gray	PL-10	PL-10	.180 Bullet/ Ring Terminal	12	0.1	8	P2 P3 PC	LIFETIME
30080Y	Yellow	Gray	PL-10	PL-10	.180 Bullet/ Ring Terminal	12	0.1	8	P2 P3 PC	LIFETIME
30090R	Red	Gray	Fit 'N Forget M/C	Fit 'N Forget M/C	Female PL-10	12	0.1	8	P2 P3 PC	3-year
30090Y	Yellow	Gray	Fit 'N Forget M/C	Fit 'N Forget M/C	Female PL-10	12	0.1	8	P2 P3 PC	3-year

PARTS INCLUDED IN KITS ABOVE

KIT #	Included Parts
30061R	30262R light, 94782 plug
30061Y	30262Y light, 94782 plug
30062R	30262R light, 94609 plug
30080R	30279R light, 94964 plug
30080Y	30279Y light, 94964 plug
30090R	30379R light, 93745 plug
30090Y	30379Y light, 93745 plug

30[®] SERIES, LED, GROMMET MOUNT, BEEHIVE

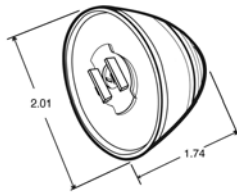

- Popular replacement for cab marker or corner trailer applications
- LEDs have no filament, therefore are not susceptible to shock and vibration
- Meets SAE 592e standards
- Less current draw, resulting in increased battery and alternator life while allowing more power for other vehicle requirements
- Red lamp has 2 diode pattern and Yellow lamp has 5 diode pattern

Part Number	Lens Color	Lamp Connector	Volts	Amps	Diodes	Lighting Codes	Warranty
30276R	Red	Fit 'N Forget M/C	12	0.05	2	P2 PC	LIFETIME
30276Y	Yellow	Fit 'N Forget M/C	12	0.05	5	P2 PC	LIFETIME

30[®] SERIES, LED, GROMMET MOUNT

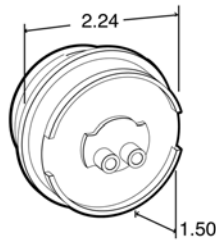

- Flange is permanently affixed to lamp
- Lamp kits include one plug or harness
- Direct pin-to-circuit board solders assure vibration resistant contacts
- Electronics completely sealed in epoxy to resist corrosion and moisture
- Low current draw, leaving more power for other vehicle requirements
- Sonically sealed lens and housing
- LEDs are less susceptible to shock and vibration
- Lamp flush mounts with a grommet or flange
- Approved to comply with ECE regulations for side marker and end outline marker functions
- Omnivolt universal lighting products address increasing vehicle power demands by operating equally in electrical systems that range from 10 to 30 volts

Part Number	Lens Color	Lamp Connector	Volts	Amps	Diodes	Lighting Codes	Warranty
30250R	Red	Fit 'N Forget M/C	12	0.05	2	P2 P3	LIFETIME
30250Y	Yellow	Fit 'N Forget M/C	12	0.05	2	P2 P3	LIFETIME
30255R	Red	Fit 'N Forget M/C	12 24	0.05	3	P2 P3	LIFETIME
30255Y	Yellow	Fit 'N Forget M/C	12 24	0.05	3	P2 P3	LIFETIME
30264Y	Yellow	PL-10	12	0.1	8	P2 PC	3-year
30270R	Red	Fit 'N Forget M/C	12	0.05	2	P2 P3	LIFETIME
30270Y	Yellow	Fit 'N Forget M/C	12	0.05	2	P2 P3	LIFETIME
30273R	Red	Fit 'N Forget M/C	12 24	0.05	3	E1	LIFETIME
30273Y	Yellow	Fit 'N Forget M/C	12 24	0.05	3	E1	LIFETIME
30275R	Red	PL-10	12	0.1	8	P2 P3 PC	3-year
30275Y	Yellow	PL-10	12	0.1	8	P2 P3 PC	3-year
30285R	Red	PL-10	12	0.12	6	P2 PC	3-year
30285Y	Yellow	PL-10	12	0.12	6	P2 PC	3-year
30375R	Red	Fit 'N Forget M/C	12	0.1	8	P2 P3 PC	LIFETIME
30375Y	Yellow	Fit 'N Forget M/C	12	0.1	8	P2 P3 PC	LIFETIME
30385R	Red	Fit 'N Forget M/C	12	0.12	6	P2 PC	LIFETIME
30385Y	Yellow	Fit 'N Forget M/C	12	0.1	6	P2 PC	LIFETIME

30[®] SERIES, LED, GROMMET MOUNT, KIT



- Flange is permanently affixed to lamp
- Lamp kits include one plug or harness
- Direct pin-to-circuit board solders assure vibration-resistant contacts
- Electronics completely sealed in epoxy to resist corrosion and moisture
- Low current draw, leaving more power for other vehicle requirements
- Sonically sealed lens and housing
- LEDs are less susceptible to shock and vibration
- Lamp flush mounts with a grommet or flange
- Approved to comply with ECE regulations for side marker and end outline marker functions
- Omnivolt universal lighting products address increasing vehicle power demands by operating equally in electrical systems that range from 10 to 30 volts

AVAILABLE CONNECTORS

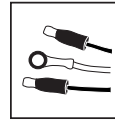

.180 BULLET/
RING TERMINAL



FEMALE
PL-10



Part Number	Lens Color	Mount Color	Lamp Connector	Plug Side 1	Plug Side 2	Volts	Amps	Diodes	Lighting Codes	Warranty
30050R	Red	Black	Fit 'N Forget M/C	Fit 'N Forget M/C	Female PL-10	12	0.05	2	P2 P3	LIFETIME
30050Y	Yellow	Black	Fit 'N Forget M/C	Fit 'N Forget M/C	Female PL-10	12	0.05	2	P2 P3	LIFETIME
30055R	Red	Black	Fit 'N Forget M/C	Fit 'N Forget M/C	Female PL-10	12 24	0.05	3	P2 P3	LIFETIME
30055Y	Yellow	Black	Fit 'N Forget M/C	Fit 'N Forget M/C	Female PL-10	12 24	0.05	3	P2 P3	LIFETIME
30070R	Red	Black	Fit 'N Forget M/C	Fit 'N Forget M/C	Female PL-10	12	0.05	2	P2 P3	LIFETIME
30070Y	Yellow	Black	Fit 'N Forget M/C	Fit 'N Forget M/C	Female PL-10	12	0.05	2	P2 P3	LIFETIME
30075R	Red	Black	PL-10	PL-10	.180 Bullet/ Ring Terminal	12	0.1	8	P2 P3 PC	LIFETIME
30075Y	Yellow	Black	PL-10	PL-10	.180 Bullet/ Ring Terminal	12	0.1	8	P2 P3 PC	3-year
30085R	Red	Black	Fit 'N Forget M/C	Fit 'N Forget M/C	Female PL-10	12	0.1	8	P2 P3 PC	3-year
30085Y	Yellow	Black	Fit 'N Forget M/C	Fit 'N Forget M/C	Female PL-10	12	0.1	8	P2 P3 PC	LIFETIME
30086R	Red	Black	Fit 'N Forget M/C	Fit 'N Forget M/C	Female PL-10	12	0.12	6	P2 PC	LIFETIME
30086Y	Yellow	Black	Fit 'N Forget M/C	Fit 'N Forget M/C	Female PL-10	12	0.12	6	P2 PC	LIFETIME

PARTS INCLUDED IN KITS ABOVE

KIT #	Included Parts
30050R	30250R light, 30700 grommet, 93745 plug
30050Y	30250Y light, 30700 grommet, 93745 plug
30055R	30255R light, 30700 grommet, 93745 plug
30055Y	30255Y light, 30700 grommet, 93745 plug
30070R	30270R light, 30700 grommet, 93745 plug
30070Y	30270Y light, 30700 grommet, 93745 plug
30075R	30275R light, 306700 grommet, 94964 plug
30075Y	30275Y light, 306700 grommet, 94964 plug
30085R	30375R light, 30700 grommet, 93745 plug
30085Y	30375Y light, 30700 grommet, 93745 plug
30086R	30385R light, 30700 grommet, 93745 plug
30086Y	30385Y light, 30700 grommet, 93745 plug

30[®] SERIES, LED, BRACKET MOUNT, KIT

LED

30 SERIES

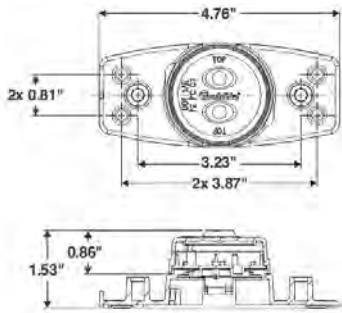

- Complies with FMVSS 108 requirements
- Brackets utilize standard military color scheme
- Kits include a deflector mount with an inner bracket that allows cam-on of the lamp for quick installation
- Manufactured out of ABS material
- OmniVolt Technology (12 or 24 volt systems will run without adjustment)
- LED life surpasses the 2000 hours of incandescent bulbs by nearly 50x
- Lens and housing assemblies constructed of impact-resistant polycarbonate
- All electronics fully sealed in epoxy, making lamps less susceptible to shock and vibration
- Faster start-up times and low current draw

Part Number	Lens Color	Mount Color	Lamp Connector	Plug Side 1	Plug Side 2	Volts	Amps Major/Minor	Diodes	Lighting Codes	Warranty
07394	Yellow	Tan	Fit 'N Forget M/C	Fit 'N Forget M/C	Female Military Boot/Ring Terminal	12 24	0.14/0.06	6	P2 PC	1-year
07395	Red	Black	Fit 'N Forget M/C	Fit 'N Forget M/C	Female Military Boot/Ring Terminal	12 24	0.14/0.06	6	P2 PC	1-year
07396	Yellow	Black	Fit 'N Forget M/C	Fit 'N Forget M/C	Female Military Boot/Ring Terminal	12 24	0.14/0.06	6	P2 PC	1-year
07393	Red	Tan	Fit 'N Forget M/C	Fit 'N Forget M/C	Female Military Boot/Ring Terminal	12 24	0.1	6	P2 PC	1-year

33[®] SERIES, LED, FLANGE MOUNT

LED

33 SERIES

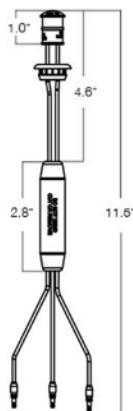

- World smallest LED marker lamp for the transportation industry
- Provides increased visibility when braking or turning
- Functions as a marker, auxiliary turn and auxiliary stop when properly installed
- Best-in-class auxiliary brake function is seven times brighter than marker function
- Marker function exceeds P2 legal requirements
- Requires a 0.75 mounting hole
- Hardwired lamp with .180 male bullet design can be easily retrofitted
- LEDs draw less current, allowing more power for other vehicle requirements
- LEDs do not have a filament, therefore are not susceptible to damage from shock and vibration
- Engineered to withstand the toughest working environments
- Electronics sealed in epoxy to resist corrosion and moisture
- Backed by our industry-leading limited Lifetime Warranty
- Complies with FMVSS-108 marker/clearance requirements

Part Number	Lens Color	Mount Color	Lamp Connector	Plug Side 1	Plug Side 2	Volts	Amps Major/Minor	Diodes	Lighting Codes	Warranty
33207R	Red	Black	Hardwired	.180 Bullet	PC	12	0.17/0.02	1	P2 PC	LIFETIME
33208R	Red	Chrome	Hardwired	.180 Bullet	PC	12	0.17/0.02	1	P2 PC	LIFETIME

33[®] SERIES, LED, FLANGE MOUNT, KIT



- World smallest LED marker lamp for the transportation industry
- Provides increased visibility when braking or turning
- Functions as a marker, auxiliary turn and auxiliary stop when properly installed
- Best-in-class auxiliary brake function is seven times brighter than marker function
- Marker function exceeds P2 legal requirements
- Requires a 0.75 mounting hole
- Hardwired lamp with .180 male bullet design can be easily retrofitted
- LEDs draw less current, allowing more power for other vehicle requirements
- LEDs do not have a filament, therefore are not susceptible to damage from shock and vibration
- Engineered to withstand the toughest working environments
- Electronics sealed in epoxy to resist corrosion and moisture & Backed by our industry-leading limited Lifetime Warranty
- Complies with FMVSS-108 marker/clearance requirements

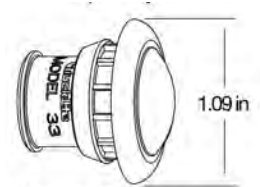

Grommet Mount

Part Number	Lens Color	Mount Color	Lamp Connector	Plug Side 1	Plug Side 2	Volts	Amps Major/Minor	Diodes	Lighting Codes	Warranty
33080R	Red	Black	Hardwired	Hardwired	.180 Bullet	12	0.14	1	P2 PC	LIFETIME
33051R	Red	Black	Hardwired	Hardwired	.180 Bullet	12	0.05	1	P2 PC	LIFETIME
33051Y	Yellow	Black	Hardwired	Hardwired	.180 Bullet	12	0.05	1	P2	LIFETIME
33080Y	Yellow	Black	Hardwired	Hardwired	.180 Bullet	12	0.14	1	PC	LIFETIME
33207Y	Yellow	Black	Hardwired	Hardwired	.180 Bullet	12	0.12/0.03	1	P2	LIFETIME
33208Y	Yellow	Chrome	Hardwired	Hardwired	.180 Bullet	12	0.12/0.03	1	P2 PC	LIFETIME

PARTS INCLUDED IN KITS ABOVE

KIT #	Included Parts
33080R	33275R light, 33800 grommet
33051R	33250R light, 33800 grommet
33051Y	33250Y light, 33800 grommet
33080Y	33275Y light, 33800 grommet
33207Y	33275Y light, 33800 grommet

Keep Your Connections Safe. Don't Forget Your Dielectric Gel.

Dielectric gel protects your lights by protecting the points of contact between elements of your lighting and harness system. Our dielectric compounds prevent arcing and corrosion and keep your lights performing as they should.

You can find our dielectric products on page 498



33[®] SERIES, LED, GROMMET MOUNT



- World's smallest LED marker lamp for the transportation industry
- Exceeds legal requirements
- Hardwired lamp design is easily retrofitted
- LEDs draw less current, allowing more power for other vehicle requirements
- Electronics completely sealed in epoxy to resist corrosion and moisture
- Offers trailer engineers and manufacturers new trailer and rear door structure design flexibility
- Requires 3/4" mounting hole
- Reduces lighting costs due to physical damage and heat entrapment

Part Number	Lens Color	Mount Color	Lamp Connector	Plug Side 1	Plug Side 2	Volts	Amps	Diodes	Lighting Codes	Warranty
33275R	Red	Black	Hardwired	Hardwired	.180 Bullet	12	0.14	1	P2 PC	LIFETIME
33285Y	Yellow	Chrome	Hardwired	Hardwired	.180 Bullet	12	0.14	1	P2 PC	LIFETIME
33285R	Red	Chrome	Hardwired	Hardwired	.180 Bullet	12	0.14	1	P2 PC	LIFETIME
33256Y	Yellow	Chrome	Hardwired	Hardwired	Ring Terminal	12	0.03	1	P2 PC	LIFETIME
33250R	Red	Chrome	Hardwired	Hardwired	.180 Bullet	12	0.05	1	P2 PC	LIFETIME
33250Y	Yellow	Chrome	Hardwired	Hardwired	.180 Bullet	12	0.05	1	P2 PC	LIFETIME
33275Y	Red	Chrome	Hardwired	Hardwired	.180 Bullet	12	0.14	1	P2 PC	LIFETIME

33[®] SERIES, LED, GROMMET MOUNT, KIT



AVAILABLE CONNECTORS



.180 BULLET

- World's smallest LED marker lamp for the transportation industry
- Provides increased visibility when braking or turning
- Functions as a marker, auxiliary turn and auxiliary stop when properly installed
- Best-in-class auxiliary brake function is seven times brighter than marker function
- Requires a 3/4" mounting hole
- Hardwired lamp with .180 male bullet design can be easily retrofitted



Part Number	Lens Color	Mount Color	Lamp Connector	Plug Side 1	Plug Side 2	Volts	Amps Major/Minor	Diodes	Lighting Codes	Warranty
33075R	Red	Black	Hardwired	Hardwired	.180 Bullet	12	0.14	1	PC	LIFETIME
33203R	Red	Black	Hardwired	Hardwired	.180 Bullet	12	0.17/0.02	1	P2 PC	LIFETIME
33204R	Red	Black	Hardwired	Hardwired	.180 Bullet	12	0.17/0.02	1	P2 PC	LIFETIME
33205R	Red	Black	Hardwired	Hardwired	.180 Bullet	12	0.17/0.02	1	P2 PC	LIFETIME
33206R	Red	Black	Hardwired	Hardwired	.180 Bullet	12	0.17/0.02	1	P2 PC	LIFETIME
33070R	Red	Black	Hardwired	Hardwired	.180 Bullet	12	0.06	1	P2	LIFETIME
33071R	Red	Black	Hardwired	Hardwired	.180 Bullet	12	0.06	1	P2 P3 PC	LIFETIME
33072R	Red	Black	Hardwired	Hardwired	.180 Bullet	12	0.06	1	P2 P3 PC	LIFETIME
33050R	Red	Black	Hardwired	Hardwired	.180 Bullet	12	0.05	1	P2	LIFETIME
33050Y	Yellow	Black	Hardwired	Hardwired	.180 Bullet	12	0.05	1	P2	LIFETIME
33075Y	Yellow	Black	Hardwired	Hardwired	.180 Bullet	12	0.14	1	PC	LIFETIME
33203Y	Yellow	Black	Hardwired	Hardwired	.180 Bullet	12	0.12/0.02	1	P2 PC	LIFETIME
33206Y	Yellow	Black	Hardwired	Hardwired	.180 Bullet	12	0.12/0.03	1	P2 PC	LIFETIME
33209Y	Yellow	Black	Hardwired	Hardwired	.180 Bullet	12	0.12/0.03	1	P2 PC	LIFETIME
33204Y	Yellow	Black	Hardwired	Hardwired	.180 Bullet	12	0.12/0.03	1	P2 PC	LIFETIME
33205Y	Yellow	Black	Hardwired	Hardwired	.180 Bullet	12	0.12/0.03	1	P2 PC	LIFETIME

PARTS INCLUDED IN KITS ABOVE

KIT #	Included Parts
33075R	33275R light, 33700 grommet
33070R	33700 grommet

KIT #	Included Parts
33071R	33720 grommet
33072R	33725 grommet

KIT #	Included Parts
33050R	33250R light, 33700 grommet
33050Y	33250Y light, 33700 grommet
33075Y	33275Y light, 33700 grommet

LED

33 SERIES

LED

33 SERIES

35[®] SERIES, LED, 2 SCREW

- US patent 7,658,524
- Exceeds legal requirements
- Hardwired lamp design is easily retrofitted
- Requires 3/4" mounting hole

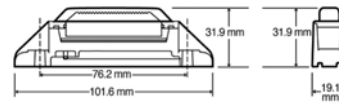

Part Number	Lens Color	Mount Color	Lamp Connector	Volts	Amps	Diodes	Lighting Codes	Warranty
35200R	Red	Red	Fit 'N Forget M/C	12	0.05	1	P2 PC	LIFETIME
35200Y	Yellow	Yellow	Fit 'N Forget M/C	12	0.05	2	P2 PC	LIFETIME
35201R	Clear Red	Clear	Fit 'N Forget M/C	12	0.05	1	P2 PC	LIFETIME
35201Y	Clear Yellow	Clear	Fit 'N Forget M/C	12	0.05	2	P2 PC	LIFETIME
35207Y	Yellow	Yellow	Fit 'N Forget M/C	12	0.08	7	E1	LIFETIME
35209Y	Yellow	Yellow	Fit 'N Forget M/C	24	0.04	7	E1	LIFETIME
35375R	Red	Red	Fit 'N Forget M/C	12	0.12	5	P2 PC	LIFETIME
35375Y	Yellow	Yellow	Fit 'N Forget M/C	12	0.12	5	P2 PC	LIFETIME
35880R	Red	Red	Fit 'N Forget M/C	12	0.05	1	P2 PC	LIFETIME
35880Y	Yellow	Yellow	Fit 'N Forget M/C	12	0.05	2	P2 PC	LIFETIME
35890R	Red	Red	Fit 'N Forget M/C	12 24	0.05	2	P2 P3	LIFETIME
35890Y	Yellow	Yellow	Fit 'N Forget M/C	12 24	0.05	2	P2 P3	LIFETIME

35[®] SERIES, LED, 2 SCREW, KIT

- OmniVolt Technology (12 or 24 volt systems will run without adjustment)
- Form/Fit/Function replacements for current product
- Lens and housing assemblies constructed of impact-resistant polycarbonate
- All electronics fully sealed in epoxy, making lamps less susceptible to shock and vibration
- Faster start-up times and low current draw

AVAILABLE CONNECTORS

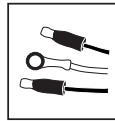

.180 BULLET/
RING TERMINAL

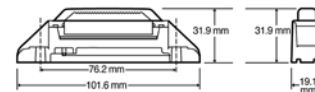

Part Number	Lens Color	Mount Color	Lamp Connector	Plug Side 1	Plug Side 2	Volts	Amps	Diodes	Lighting Codes	Warranty
35001R	Red	Red	Fit 'N Forget M/C	Fit 'N Forget M/C	.180 Bullet/Ring Terminal	12	0.05	1	P2 PC	LIFETIME
35001Y	Yellow	Yellow	Fit 'N Forget M/C	Fit 'N Forget M/C	.180 Bullet/Ring Terminal	12	0.05	1	P2 PC	LIFETIME
35004R	Red	Red	Fit 'N Forget M/C	Fit 'N Forget M/C	.180 Bullet/Ring Terminal	12 24	0.05	2	P2 P3	LIFETIME
35004Y	Yellow	Yellow	Fit 'N Forget M/C	Fit 'N Forget M/C	.180 Bullet/Ring Terminal	12 24	0.05	2	P2 P3	LIFETIME
35007Y	Yellow	Yellow	Fit 'N Forget M/C	Fit 'N Forget M/C	.180 Bullet/Ring Terminal	12	0.08	7	E1	LIFETIME
35009Y	Yellow	Yellow	Fit 'N Forget M/C	Fit 'N Forget M/C	.180 Bullet/Ring Terminal	24	0.04	7	E1	LIFETIME
35075R	Red	Red	Fit 'N Forget M/C	Fit 'N Forget M/C	.180 Bullet/Ring Terminal	12	0.12	5	P2 PC	LIFETIME
35075Y	Yellow	Yellow	Fit 'N Forget M/C	Fit 'N Forget M/C	.180 Bullet/Ring Terminal	12	0.12	5	P2 PC	LIFETIME
35080R	Red	Red	Fit 'N Forget M/C	Fit 'N Forget M/C	.180 Bullet/Ring Terminal	12	0.05	1	P2 PC	LIFETIME
35080Y	Yellow	Yellow	Fit 'N Forget M/C	Fit 'N Forget M/C	.180 Bullet/Ring Terminal	12	0.05	2	P2 PC	LIFETIME

PARTS INCLUDED IN KITS ABOVE

KIT #	Included Parts	KIT #	Included Parts	KIT #	Included Parts	KIT #	Included Parts
35001R	35200R light, 94862	35004Y	35890Y light, 94862	35075R	35375R light, 94892 plug	35080Y	35880Y light, 94862 plug
35001Y	35200Y light, 94862	35007Y	35207Y light, 94862 plug	35075Y	35375Y light, 94892 plug		
35004R	35890R light, 94862	35009Y	35209Y light	35080R	35880R light, 94862 plug		

36 SERIES, LED, ADHESIVE MOUNT

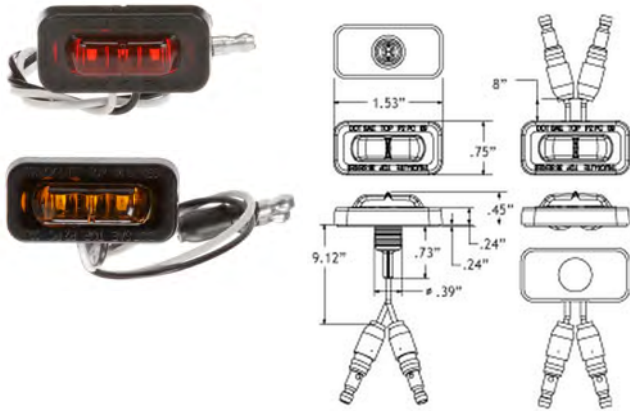

- Lamps operate in minor and major output levels: major function activated by the brake function or turn signal
- Yellow major function is three times brighter than minor function
- Red major function is seven times brighter than minor function
- Provides marker/clearance solution that requires no mounting brackets or installation screws
- Lamps adhere directly to application surface through use of heavy-duty adhesive backing
- P2-Rated
- Electronics are completely sealed in epoxy to resist damage caused by moisture and corrosion
- Easy-to-install, peel-off liner
- Rear exit wire version requires a 3/8" mounting hole, and self-seals hole upon installation
- Care should be taken for proper installation

Part Number	Lens Color	Mount Color	Lamp Connector	Plug Side 1	Plug Side 2	Volts	Amps Major/Minor	Diodes	Lighting Codes	Warranty
36203R	Red	Black	Hardwired	Hardwired	.180 Bullet	12	0.06/0.01	3	P2	LIFETIME
36203Y	Yellow	Black	Hardwired	Hardwired	.180 Bullet	12	0.06/0.02	3	P2	LIFETIME
36105R	Red	Black	Hardwired	Hardwired	.180 Bullet	12	0.03	3	P2 PC	LIFETIME
36105Y	Yellow	Black	Hardwired	Hardwired	.180 Bullet	12	0.05	3	P2 PC	LIFETIME
36115R	Red	Black	Hardwired	Hardwired	.180 Bullet	12	0.03	3	P2 PC	LIFETIME
36115Y	Yellow	Black	Hardwired	Hardwired	.180 Bullet	12	0.05	3	P2 PC	LIFETIME

36 SERIES, LED, ADHESIVE MOUNT/2 SCREW, WINGED



- Winged housing provides option for mounting around corners on a radius
- Provides a clearance/marker solution that requires no mounting brackets or installation screws
- Lamps adhere directly to application surface through the use of heavy-duty adhesive backing
- Easy-to-install, peel-off liner
- Hardwired lamp design is easily retrofitted
- Rear exit wire version requires a 3/8" mounting hole, and self-seals hole upon installation
- Side mount options can be mounted without any mounting holes
- LEDs draw much less current, allowing more power for other vehicle requirements
- Electronics are completely sealed in epoxy to resist damage caused by moisture and corrosion
- Reduces lighting costs caused by physical damage and heat entrapment

Part Number	Lens Color	Mount Color	Lamp Connector	Plug Side 1	Plug Side 2	Volts	Amps Major/Minor	Diodes	Lighting Codes	Warranty
36100R	Red	Black	Hardwired	Hardwired	.180 Bullet	12	0.03	3	P2 PC	LIFETIME
36100Y	Yellow	Black	Hardwired	Hardwired	.180 Bullet	12	0.05	3	P2 PC	LIFETIME
36110R	Red	Black	Hardwired	Hardwired	.180 Bullet	12	0.03	3	P2 PC	LIFETIME
36110Y	Yellow	Black	Hardwired	Hardwired	.180 Bullet	12	0.05	3	P2 PC	LIFETIME
36213R	Red	Black	Hardwired	Hardwired	.180 Bullet	12	0.06/0.01	3	P2 PC	LIFETIME
36130R	Red	Black	Hardwired	Hardwired	.180 Bullet/ Female .180 Bullet	12 24	0.05	3	P2 PC	LIFETIME
36130Y	Yellow	Black	Hardwired	Hardwired	.180 Bullet/ Female .180 Bullet	12 24	0.05	3	P2 PC	LIFETIME

LED

36 SERIES

LED

36 SERIES

10[®] SERIES, INCANDESCENT, GROMMET MOUNT

- Lens and housing are sonically sealed
- High-impact polycarbonate construction
- 15,000-hour-rated bulb life
- Available in either 12 volt or 24 volt
- Meets PC requirement on a 45-degree angle in mounting devices #10708, #10720, #00803 or #00804
- Replaces Signal-Stat 1010 and 1011 series



Part Number	Lens Color	Lamp Connector	Volts	Amps	Bulbs	Lighting Codes	Warranty
10202B	Blue	PL-10	12	0.33	1	P2 PC	1-year
10202G	Green	PL-10	12	0.33	1	P2 PC	1-year
10202R	Red	PL-10	12	0.33	1	P2 PC	1-year
10202Y	Yellow	PL-10	12	0.33	1	P2 PC	1-year
10204R	Red	PL-10	24	0.17	1	P2 PC	1-year
10204Y	Yellow	PL-10	24	0.17	1	P2 PC	1-year

10[®] SERIES, INCANDESCENT, GROMMET MOUNT, REFLECTORIZED

- Lens and housing are sonically sealed
- High-impact polycarbonate construction
- 15,000-hour-rated bulb life
- Available in either 12 volt or 24 volt
- Meets PC requirement on a 45-degree angle in mounting devices #10708, #10720, #00803 or #00804
- Replaces Signal-Stat 1010 and 1011 series



Part Number	Lens Color	Mount Color	Lamp Connector	Plug Side 1	Plug Side 2	Volts	Amps	Bulbs	Lighting Codes	Warranty
10205R	Red		PL-10			12	0.33	1	A P2 PC	1-year
10205Y	Yellow		PL-10			12	0.33	1	A P2 PC	1-year

10[®] SERIES, INCANDESCENT, GROMMET MOUNT, REFLECTORIZED, KIT



- Lens and housing are sonically sealed
- High-impact polycarbonate construction
- 15,000-hour-rated bulb life
- Available in either 12 or 24 volt
- Meets PC requirement on a 45-degree angle in mounting devices #10708, #10720, #00803 or #00804
- Replaces Signal-Stat 1010 and 1011 series

AVAILABLE CONNECTORS

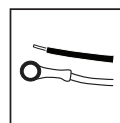

RING TERMINAL / STRIPPED END



Part Number	Lens Color	Mount Color	Lamp Connector	Plug Side 1	Plug Side 2	Volts	Amps	Bulbs	Lighting Codes	Warranty
10525R	Red	Black	PL-10	PL-10	Ring Terminal/ Stripped End	12	0.33	1	A P2 PC	1-year
10525Y	Yellow	Black	PL-10	PL-10	Ring Terminal/ Stripped End	12	0.33	1	A P2 PC	1-year

PARTS INCLUDED IN KITS ABOVE

KIT #	Included Parts
10525R	10205R light, 10700 grommet, 94902 plug
10525Y	10205Y light, 10700 grommet, 94902 plug

10[®] SERIES, INCANDESCENT, BRACKET MOUNT, KIT



AVAILABLE CONNECTORS

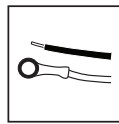

RING TERMINAL / STRIPPED END

- Rust-resistant stainless steel mount
- Quick cam-on, cam-off lamp installation
- Suitable for PC requirements on a 45-degree angle using all 2-1/2" diameter lamps
- Mounts with screws to surface
- Model 10 kits available
- Not recommended for use with Signal-Stat LED products
- Replaces Signal-Stat 9394



Part Number	Lens Color	Mount Color	Lamp Connector	Plug Side 1	Plug Side 2	Volts	Amps	Bulbs	Lighting Codes	Warranty
10520R	Red	Gray	PL-10	PL-10	Ring Terminal Stripped End	12	0.33	1	P2 PC	1-year
10520Y	Yellow	Gray	PL-10	PL-10	Ring Terminal Stripped End	12	0.33	1	P2 PC	1-year
10004R	Red	Silver	PL-10	PL-10	Ring Terminal Stripped End	12	0.33	1	A P2 PC	1-year
10004Y	Yellow	Silver	PL-10	PL-10	Ring Terminal Stripped End	12	0.33	1	A P2 PC	1-year

PARTS INCLUDED IN KITS ABOVE

KIT #	Included Parts	KIT #	Included Parts
10520R	10202R light, 10700 grommet, 94902 plug	10004R	10720 bracket, 94902 grommet
10520Y	10202Y light, 10700 grommet, 94902 plug	10004Y	10720 bracket, 94902 grommet

10[®] SERIES, INCANDESCENT, GROMMET MOUNT, BEEHIVE

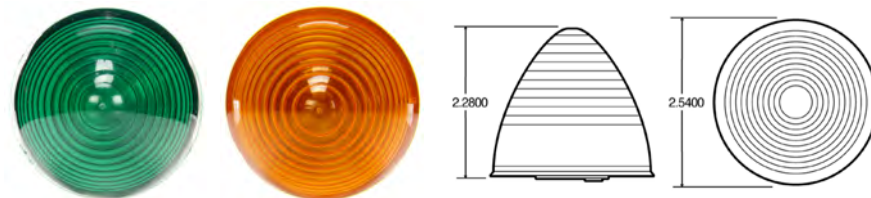

- Features a beehive lens designed for cab marker use
- Lens and housing are sonically sealed
- High impact polycarbonate construction
- 12 volt, 15,000-hour-rated bulb
- Suitable for PC requirements on a 45-degree angle in mounting devices #10708, #10720, #00801, #00803, or #00804
- Upgrade to LED use Truck-Lite part no. 10276R/Y or Signal-Stat part no. 1075/1075A

Part Number	Lens Color	Lamp Connector	Volts	Amps	Bulbs	Lighting Codes	Warranty
10203B	Blue	PL-10	12	0.33	1	P2 P3 PC	1-year
10203G	Green	PL-10	12	0.33	1	P2 P3 PC	1-year
10203R	Red	PL-10	12	0.33	1	P2 P3 PC	1-year
10203Y	Yellow	PL-10	12	0.33	1	P2 P3 PC	1-year

INCANDESCENT

10 SERIES

INCANDESCENT

10 SERIES

SUPER 10® SERIES, INCANDESCENT, GROMMET MOUNT

- Unique shock-mount extends bulb life
- 15,000-hour-rated bulb life
- Sealed polycarbonate lens and housing
- Meets PC requirements on a 45-degree angle using all mounting devices

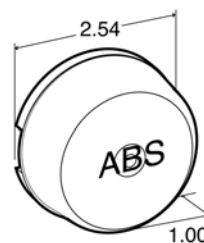

Part Number	Lens Color	Lamp Connector	Volts	Amps	Bulbs	Lighting Codes	Warranty
10212Y	Yellow	PL-10	12	0.33	1	P2 PC	2-year
10213Y	Yellow	PL-10	12	0.33	1	P2 PC	2-year

INCANDESCENT

SUPER 10 SERIES

SUPER 10® SERIES, INCANDESCENT, GROMMET MOUNT, KIT



- Unique shock-mount extends bulb life
- 15,000-hour-rated bulb life
- Sealed polycarbonate lens and housing
- Meets PC requirements on a 45-degree angle using all mounting devices

AVAILABLE CONNECTORS

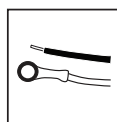

RING TERMINAL / STRIPPED END

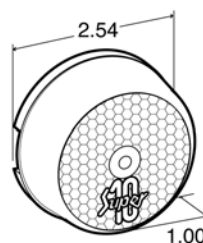

Part Number	Lens Color	Mount Color	Lamp Connector	Plug Side 1	Plug Side 2	Volts	Amps	Bulbs	Lighting Codes	Warranty
10028R	Red	Black	PL-10	PL-10	Ring Terminal/Stripped End	12	0.33	1	P2 PC	2-year
10028Y	Yellow	Black	PL-10	PL-10	Ring Terminal/Stripped End	12	0.33	1	P2 PC	2-year

PARTS INCLUDED IN KITS ABOVE

KIT #	Included Parts
10028R	10208r light, 10700 grommet, 94902 plug
10028Y	10208y light, 10700 grommet, 94902 plug

SUPER 10® SERIES, INCANDESCENT, GROMMET MOUNT, REFLECTORIZED

- Unique shock-mount extends bulb life
- 15,000-hour-rated bulb life
- Sealed polycarbonate lens and housing
- Meets PC requirements on a 45 degree angle using all mounting devices

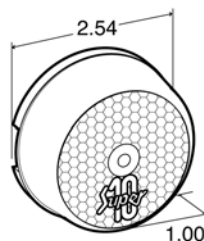

Part Number	Lens Color	Lamp Connector	Volts	Amps	Bulbs	Lighting Codes	Warranty
10208R	Red	PL-10	12	0.33	1	A P2 PC	2-year
10208Y	Yellow	PL-10	12	0.33	1	A P2 PC	2-year

INCANDESCENT

SUPER 10 SERIES

12[®] SERIES, INCANDESCENT, BRACKET MOUNT, KIT

INCANDESCENT

12 SERIES

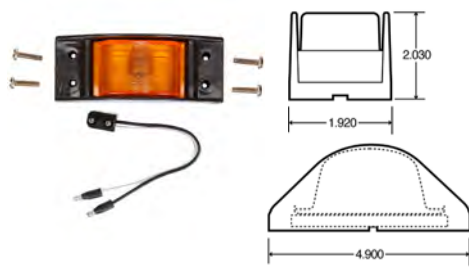

AVAILABLE CONNECTORS

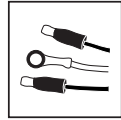

.180 BULLET/
RING TERMINAL

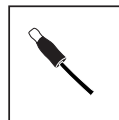

.156 BULLET

- High-impact plastic branch deflector mount
- Snap-in lamp design for easy replacement
- SAE PC-rated for combination clearance/marker applications
- Standard replacement on UPS models



Part Number	Lens Color	Mount Color	Lamp Connector	Plug Side 1	Plug Side 2	Volts	Amps	Bulbs	Lighting Codes	Warranty
12004R	Red	Brown	PL-10			12	0.33	1	P2 PC	1-year
12004Y	Yellow	Brown	PL-10			12	0.33	1	P2 PC	1-year
12001R	Red	Brown	PL-10	PL-10	.156 Bullet	12	0.33	1	P2 PC	1-year
12001Y	Yellow	Brown	PL-10	PL-10	.156 Bullet	12	0.33	1	P2 PC	1-year
12003R	Red	Gray	PL-10	PL-10	Ring Terminal/ Stripped End	12	0.33	1	P2 PC	1-year
12003Y	Yellow	Gray	PL-10	PL-10	Ring Terminal/ Stripped End	12	0.33	1	P2 PC	1-year

PARTS INCLUDED IN KITS ABOVE

KIT #	Included Parts
12004R	12200R light, 12724 bracket
12004Y	12200Y light, 12724 bracket
12001R	12200R light, 94850 plug
12001Y	12200Y light, 94850 plug
12003R	12200R light, 12723 bracket, 94919 plug
12003Y	12200Y light, 12723 bracket, 94919 plug

12[®] SERIES, INCANDESCENT, GROMMET MOUNT

INCANDESCENT

12 SERIES

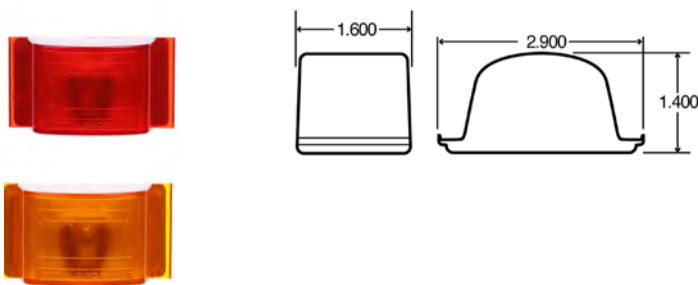

- Features a beehive lens designed for cab marker use
- Lens and housing are sonically sealed
- High impact polycarbonate construction
- 12 volt, 15,000-hour-rated bulb
- Suitable for PC requirements on a 45-degree angle in mounting devices #10708, #10720, #00801, #00803, or #00804
- Upgrade to LED use Truck-Lite part #10276R/Y or Signal-Stat part #1075/1075A

Part Number	Lens Color	Lamp Connector	Volts	Amps	Bulbs	Lighting Codes	Warranty
12200R	Red	PL-10	12	0.33	1	P2 PC	1-year
12200Y	Yellow	PL-10	12	0.33	1	P2 PC	1-year
12201R	Red	PL-10	24	0.17	1	P2 PC	1-year
12201Y	Yellow	PL-10	24	0.17	1	P2 PC	1-year

13 SERIES, INCANDESCENT, BOLT & NUT MOUNT

- Sonically sealed lens and housing protect a heavy-duty, shock-mounted, single-filament bulb
- High-impact polycarbonate construction
- Functions include front outline marker (clear), ABS warning (green), end outline marker (red) and side marker (yellow)

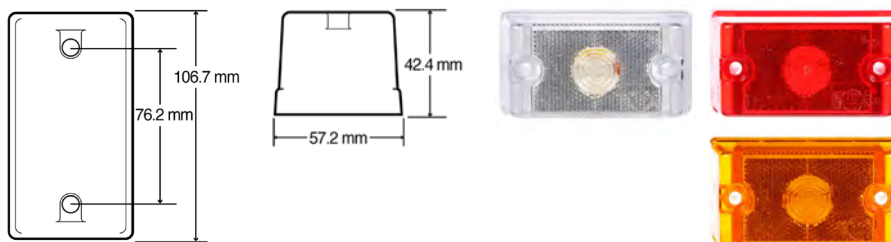

Part Number	Lens Color	Mount Color	Lamp Connector	Volts	Amps	Bulbs	Lighting Codes	Warranty
13200C	Clear	Clear	Super 21 Plug	24	0.35	1	E1	1-year
13200R	Red	Red	Super 21 Plug	24	0.35	1	E1	1-year
13200Y	Yellow	Yellow	Super 21 Plug	24	0.35	1	E1	1-year
13210C	Clear	Clear	Super 21 Plug	12	0.69	1	E1	1-year
13210R	Red	Red	Super 21 Plug	12	0.69	1	E1	1-year
13210Y	Yellow	Yellow	Super 21 Plug	12	0.69	1	E1	1-year

13 SERIES, INCANDESCENT, BOLT & NUT MOUNT, KIT



- Sonically sealed lens and housing protect a heavy-duty, shock-mounted, single-filament bulb
- High-impact polycarbonate construction
- Functions include front outline marker (clear), ABS warning (green), end outline marker (red) and side marker (yellow)

AVAILABLE CONNECTORS

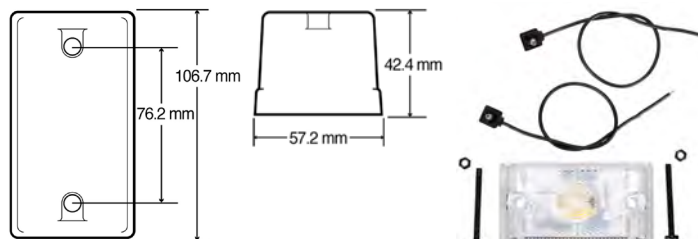
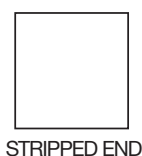

Part Number	Lens Color	Mount Color	Lamp Connector	Plug Side 1	Plug Side 2	Volts	Amps	Bulbs	Lighting Codes	Warranty
13001R	Red	Red	Super 21 Plug	Super 21 Plug	Stripped End	24	0.35	1	E1	1-year
13001Y	Yellow	Yellow	Super 21 Plug	Super 21 Plug	Stripped End	24	0.35	1	E1	1-year
13011C	Clear	Clear	Super 21 Plug	Super 21 Plug	Stripped End	12	0.69	1	E1	1-year
13011R	Red	Red	Super 21 Plug	Super 21 Plug	Stripped End	12	0.69	1	E1	1-year
13011Y	Yellow	Yellow	Super 21 Plug	Super 21 Plug	Stripped End	12	0.69	1	E1	1-year
13001C	Clear	White	Super 21 Plug	Super 21 Plug	Stripped End	24	0.35	1	E1	1-year
13001G	Green	Clear	Super 21 Plug	Super 21 Plug	Stripped End	24	0.35	1	E1	1-year

PARTS INCLUDED IN KITS ABOVE

KIT #	Included Parts
13001R	13200R light, 96930 plug
13001Y	13200Y light, 96930 plug
13011C	13210C light, 95911 hardware, 96930 plug
13011R	13210C light, 95911 hardware, 96930 plug

KIT #	Included Parts
13011Y	13210C light, 95911 hardware, 96930 plug
13001C	13200C light, 96930 plug
13001G	13200C light, 96930 plug

14 SERIES, INCANDESCENT, GROMMET MOUNT, REFLECTORIZED

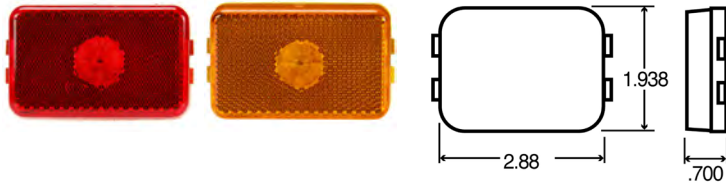

- Sonically sealed lens and housing
- Features snap-in lamp with reflector
- 12 and 24-volt versions available
- Long-life, 15,000-hour, 12 volt bulb
- Grommets flush-mount the lamp to vehicle
- Not suitable for PC requirements
- Replaces Signal-Stat 1017/1017A and 9138

Part Number	Lens Color	Lamp Connector	Volts	Amps	Bulbs	Lighting Codes	Warranty
14200R	Red	PL-10	12	0.33	1	A P2	1-year
14200Y	Yellow	PL-10	12	0.33	1	A P2	1-year

15[®] SERIES, INCANDESCENT, BRACKET MOUNT



- Fits in most narrow header rails
- Mounts vertically or horizontally
- Long-life, 15,000-hour bulb
- Snap-lock tabs allow quick and easy installation
- Suitable for PC requirements on a 45-degree angle

Part Number	Lens Color	Lamp Connector	Volts	Amps	Bulbs	Lighting Codes	Warranty
15200R	Red	PL-10	12	0.33	1	P2 PC	2-year
15200Y	Yellow	PL-10	12	0.33	1	P2 PC	2-year
15201R	Red	PL-10	24	0.17	1	P2 PC	2-year
15201Y	Yellow	PL-10	24	0.17	1	P2 PC	2-year

15[®] SERIES, INCANDESCENT, BRACKET MOUNT, ABS

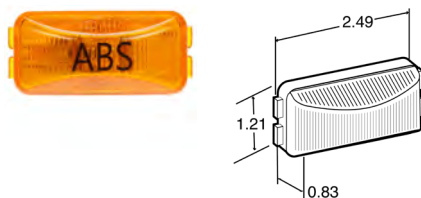

- Fits in most narrow header rails
- Mounts vertically or horizontally
- Long-life, 15,000-hour bulb
- Snap-lock tabs allow quick and easy installation.
- Suitable for PC requirements on a 45-degree angle

Part Number	Lens Color	Lamp Connector	Volts	Amps	Bulbs	Lighting Codes	Warranty
15203Y	Yellow	PL-10	12	0.33	1	P2 PC	2-year

15[®] SERIES, INCANDESCENT, BRACKET MOUNT, KIT



- Extra-strength plastic construction
- Features top cut-out area on mount #15727 for narrow rail design
- Easy snap-in lamp installation
- Suitable for PC requirements with incandescent lamps

AVAILABLE CONNECTORS



RING TERMINAL / STRIPPED END



BLUNT CUT



STRIPPED END

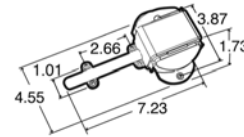

Part Number	Lens Color	Mount Color	Lamp Connector	Plug Side 1	Plug Side 2	Volts	Amps	Bulbs	Lighting Codes	Warranty
15006R	Red	White	PL-10	PL-10	Ring Terminal/Stripped End	12	0.33	1	P2 PC	1-year
15006Y	Yellow	White	PL-10	PL-10	Ring Terminal/Stripped End	12	0.33	1	P2 PC	1-year
15008R	Red	White	PL-10	PL-10	Ring Terminal/Stripped End	12	0.33	1	P2 PC	1-year
15008Y	Yellow	White	PL-10	PL-10	Ring Terminal/Stripped End	12	0.33	1	P2 PC	1-year
15415	Red Yellow	Black	Fit 'N Forget M/C	Fit 'N Forget M/C	Blunt Cut	12	0.33	1	P2 PC	1-year
15416	Red Yellow	Black	Fit 'N Forget M/C	Fit 'N Forget M/C	Blunt Cut	12	0.33	1	P2 PC	1-year
15506R	Red	Chrome	.156 Bullet Hot Wire	.156 Bullet Hot Wire	Stripped End	12	0.33	1	P2 PC	1-year
15506Y	Yellow	Chrome	.156 Bullet Hot Wire	.156 Bullet Hot Wire	Stripped End	12	0.33	1	P2 PC	1-year
15507R	Red	Black	.156 Bullet Hot Wire	.156 Bullet Hot Wire	Stripped End	12	0.33	1	P2 PC	1-year
15507Y	Yellow	Black	.156 Bullet Hot Wire	.156 Bullet Hot Wire	Stripped End	12	0.33	1	P2 PC	1-year

PARTS INCLUDED IN KITS ABOVE

KIT #	Included Parts
15006R	15200R light, 15727 bracket, 94924 plug
15006Y	15200Y light, 15727 bracket, 94924 plug
15008R	15200R light, 15728 bracket, 94924 plug
15008Y	15200Y light, 15728 bracket, 94924 plug
15415	15200R light, 15731 bracket

KIT #	Included Parts
15416	15200Y light, 15731 bracket
15506R	15200R light, 793 bracket, 96904 plug
15506Y	15200Y light, 793 bracket, 96904 plug
15507R	15200R light, 809 bracket
15507Y	15200Y light, 809 bracket

18[®] SERIES, INCANDESCENT, 2 SCREW, REFLECTORIZED, KIT



- Sonically welded lens and housing
- Replaceable bulb
- Not suitable for PC requirements
- Replaces Signal-Stat 1572/1572A

AVAILABLE CONNECTORS



RING TERMINAL / STRIPPED END

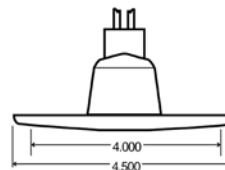
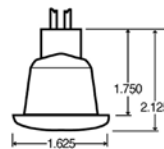

Part Number	Lens Color	Mount Color	Lamp Connector	Plug Side 1	Plug Side 2	Volts	Amps	Bulbs	Lighting Codes	Warranty
18300R	Red	Red	Socket Assembly	Socket Assembly	Ring Terminal/Stripped End	12	0.27	1	A P2	1-year
18300Y	Yellow	Yellow	Socket Assembly	Socket Assembly	Ring Terminal/Stripped End	12	0.27	1	A P2	1-year

PARTS INCLUDED IN KITS ABOVE

KIT #	Included Parts
18300R	99012R light, 97927 grommet, 94940 plug
18300Y	99012Y light, 97927 grommet, 94940 plug

INCANDESCENT

15 SERIES

INCANDESCENT

18 SERIES

19[®] SERIES, INCANDESCENT, 2 SCREW, KIT

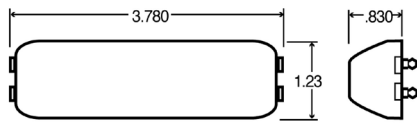

- Features unique plug-in design for ease of installation
- Low profile extra-strength base
- Suitable for pc requirements on a 45-degree angle



Part Number	Lens Color	Mount Color	Lamp Connector	Plug Side 1	Plug Side 2	Volts	Amps	Bulbs	Lighting Codes	Warranty
19002R	Red	Gray	Hardwired	Hardwired	Stripped End	12	0.33	2	P2 PC	1-year
19002Y	Yellow	Gray	Hardwired	Hardwired	Stripped End	12	0.33	2	P2 PC	1-year
19009R	Red	Chrome	Hardwired	Hardwired	Stripped End	12	0.33	2	P2 PC	1-year
19009Y	Yellow	Chrome	Hardwired	Hardwired	Stripped End	12	0.33	2	P2 PC	1-year

PARTS INCLUDED IN KITS ABOVE

KIT #	Included Parts	KIT #	Included Parts
19002R	19200R light, 19721 bracket	19009R	19200R light, 19739 bracket
19002Y	19200R light, 19721 bracket	19009Y	19200Y light, 19739 bracket

19[®] SERIES, INCANDESCENT, BRACKET MOUNT

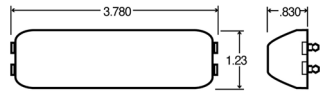

- Designed to fit in limited mounting areas
- Fits in most narrow header rails
- Can be mounted vertically or horizontally
- Snap-lock tabs allow quick and easy installation
- Replaces Signal-Stat 1900 series

Part Number	Lens Color	Lamp Connector	Volts	Amps	Bulbs	Lighting Codes	Warranty
19200R	Red	19 Series Male Pin	12	0.33	2	P2 P3 PC	1-year
19200Y	Yellow	Fit 'N Forget M/C	12	0.33	2	P2 P3 PC	1-year
19205Y	Yellow	Fit 'N Forget M/C	12	0.33	2	P2 P3 PC	1-year

19[®] SERIES, INCANDESCENT, BRACKET MOUNT, KIT

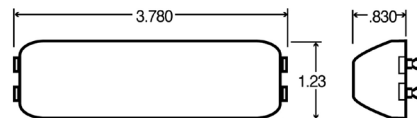

- Features unique plug-in design for ease of installation
- Low profile extra strength base
- Suitable for pc requirements on a 45-degree angle



Part Number	Lens Color	Mount Color	Lamp Connector	Volts	Amps	Bulbs	Lighting Codes	Warranty
19016R	Red	Black	19 Series Male Pin	12	0.33	2	P2 PC	1-year
19016Y	Yellow	Black	19 Series Male Pin	12	0.33	2	P2 PC	1-year

PARTS INCLUDED IN KITS ABOVE

KIT #	Included Parts
19016R	19200R light, 19728 bracket
19016Y	19200Y light, 19728 bracket

INCANDESCENT

19 SERIES

INCANDESCENT

19 SERIES

INCANDESCENT

19 SERIES

21[®] SERIES, INCANDESCENT, 2 SCREW

- Available with standard or reflectorized lens
- Features male pin connections
- Suitable for PC requirements on a 45-degree angle with additional reflectors

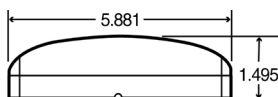

Part Number	Lens Color	Mount Color	Lamp Connector	Volts	Amps	Bulbs	Lighting Codes	Warranty
29202R	Red	Red	Male Pin	12	0.33	2	P2 PC	1-year
29202Y	Yellow	Yellow	Male Pin	12	0.33	2	P2 PC	1-year

INCANDESCENT

21 SERIES

21[®] SERIES, INCANDESCENT, 2 SCREW, KIT



- Available with standard or reflectorized lens
- Features male pin connections
- Suitable for PC requirements on a 45-degree angle with additional reflectors

AVAILABLE CONNECTORS

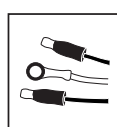

.180 BULLET/
RING TERMINAL

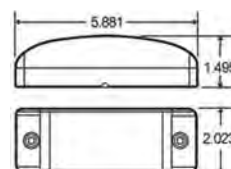

Part Number	Lens Color	Mount Color	Lamp Connector	Plug Side 1	Plug Side 2	Volts	Amps	Bulbs	Lighting Codes	Warranty
29002R	Red	Red	Male Pin	Male Pin	.180 Bullet/ Ring Terminal	12	0.33	2	P2 PC	1-year
29002Y	Yellow	Yellow	Male Pin	Male Pin	.180 Bullet/ Ring Terminal	12	0.33	2	P2 PC	1-year

PARTS INCLUDED IN KITS ABOVE

KIT #	Included Parts
29002R	29202R light, 96106 plug
29002Y	29202Y light, 96106 plug

INCANDESCENT

21 SERIES

21 SERIES, INCANDESCENT, 2 SCREW, REFLECTORIZED

- Available with standard or reflectorized lens
- Features male pin connections
- Suitable for PC requirements on a 45-degree angle with additional reflectors

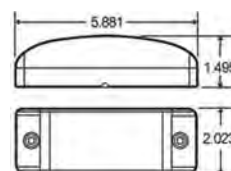

Part Number	Lens Color	Mount Color	Lamp Connector	Volts	Amps	Bulbs	Lighting Codes	Warranty
29203R	Red	Red	Male Pin	12	0.33	2	A P2 PC	1-year
29203Y	Yellow	Yellow	Male Pin	12	0.33	2	A P2 PC	1-year

INCANDESCENT

21 SERIES

21[®] SERIES, INCANDESCENT, 2 SCREW, REFLECTORIZED, KIT

INCANDESCENT

21 SERIES

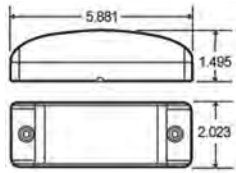

AVAILABLE CONNECTORS

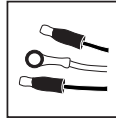

.180 BULLET/
RING TERMINAL

- Available with standard or reflectorized lens
- Features male pin connections
- Suitable for PC requirements on a 45-degree angle with additional reflectors



Part Number	Lens Color	Mount Color	Lamp Connector	Plug Side 1	Plug Side 2	Volts	Amps	Bulbs	Lighting Codes	Warranty
29003R	Red	Red	Male Pin	Male Pin	.180 Bullet/ Ring Terminal	12	0.33	2	A P2 PC	1-year
29003Y	Yellow	Yellow	Male Pin	Male Pin	.180 Bullet/ Ring Terminal	12	0.33	2	A P2 PC	1-year

PARTS INCLUDED IN KITS ABOVE

KIT #	Included Parts
29003R	29203R light, 96106 plug
29003Y	29203Y light, 96106 plug

SUPER 21[®] SERIES, INCANDESCENT, 2 SCREW

INCANDESCENT

SUPER 21 SERIES

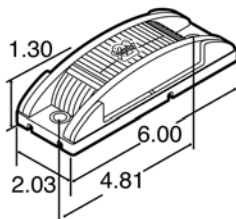

- Available with standard or reflectorized lens
- Suitable for PC requirements on a 45-degree angle with additional reflectors
- Version available for ABS requirements
- Optional gaskets available to improve seal between lamp and body
- Kits with extension brackets are a direct replacement for Utility Trailer #03-5100-0-097/8

Part Number	Lens Color	Mount Color	Lamp Connector	Volts	Amps	Bulbs	Lighting Codes	Warranty
21200R	Red	Red	Super 21 Plug	12	0.33	1	P2 PC	2-year
21200Y	Yellow	Yellow	Super 21 Plug	12	0.33	1	P2 PC	2-year
21205R	Red	Red	Super 21 Plug	24	0.17	1	P2 PC	2-year
21205Y	Yellow	Yellow	Super 21 Plug	24	0.17	1	A P2 PC	2-year
21210Y	Yellow	Yellow	Super 21 Plug	12	0.33	1	P2 PC	2-year
21506R	Red	Red	Self-Piercing Plug	12	0.33	1	P2 PC	2-year
21506Y	Yellow	Yellow	Self-Piercing Plug	12	0.33	1	P2 PC	2-year

SUPER 21® SERIES, INCANDESCENT, 2 SCREW, KIT



- Available with standard or reflectorized lens
- Suitable for PC requirements on a 45-degree angle with additional reflectors
- Version available for ABS requirements
- Optional gaskets available to improve seal between lamp and body
- Kits with extension brackets are a direct replacement for Utility Trailer #03-5100-0-097/8

AVAILABLE CONNECTORS

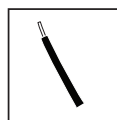

STRIPPED END

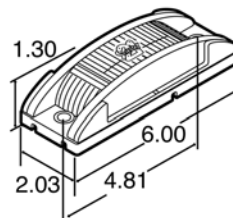

Part Number	Lens Color	Mount Color	Lamp Connector	Plug Side 1	Plug Side 2	Volts	Amps	Bulbs	Lighting Codes	Warranty
21001R	Red	Red	Super 21 Plug	Super 21 Plug	Stripped End	12	0.17	1	P2 PC	2-year
21001Y	Yellow	Yellow	Super 21 Plug	Super 21 Plug	Stripped End	12	0.17	1	P2 PC	2-year
21005R	Red	Red	Super 21 Plug	Super 21 Plug	Stripped End	24	0.17	1	P2 PC	2-year
21005Y	Yellow	Yellow	Super 21 Plug	Super 21 Plug	Stripped End	24	0.17	1	P2 PC	2-year

PARTS INCLUDED IN KITS ABOVE

KIT #	Included Parts
21001R	21200R light, 96930 plug
21001Y	21200Y light, 96930 plug
21005R	21205R light, 96930 plug
21005Y	21205Y light, 96930 plug

SUPER 21® SERIES, INCANDESCENT, 2 SCREW, REFLECTORIZED

- Available with standard or reflectorized lens
- Suitable for PC requirements on a 45-degree angle with additional reflectors
- Version available for ABS requirements
- Optional gaskets available to improve seal between lamp and body
- Kits with extension brackets are a direct replacement for Utility Trailer #03-5100-0-097/8

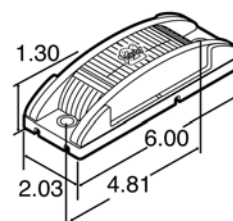

Part Number	Lens Color	Mount Color	Lamp Connector	Volts	Amps	Bulbs	Lighting Codes	Warranty
21201R	Red	Red	Super 21 Plug	12	0.33	1	A P2	2-year
21201Y	Yellow	Yellow	Super 21 Plug	12	0.33	1	A P2	2-year

INCANDESCENT

SUPER 21 SERIES

INCANDESCENT

SUPER 21 SERIES

INCANDESCENT

SUPER 21 SERIES

SUPER 21® SERIES, INCANDESCENT, 2 SCREW, KIT, REFLECTORIZED

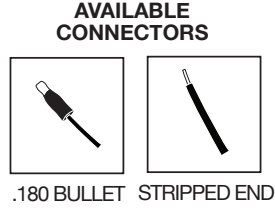
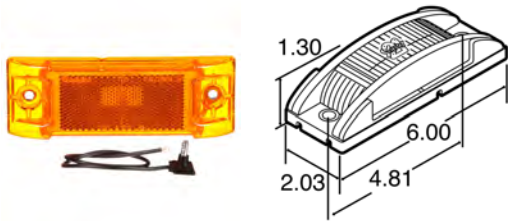

- Available with standard or reflectorized lens
- Suitable for PC requirements on a 45-degree angle with additional reflectors
- Version available for ABS requirements
- Optional gaskets available to improve seal between lamp and body
- Kits with extension brackets are a direct replacement for Utility Trailer #03-5100-0-097/8

Part Number	Lens Color	Mount Color	Lamp Connector	Plug Side 1	Plug Side 2	Volts	Amps	Bulbs	Lighting Codes	Warranty
21002R	Red	Red	Super 21 Plug	Super 21 Plug	Stripped End	12	0.33	1	A P2	2-year
21002Y	Yellow	Yellow	Super 21 Plug	Super 21 Plug	Stripped End	12	0.33	1	A P2	2-year
21501R	Red	Red	Super 21 Plug	Super 21 Plug	.180 Bullet	12	0.33	1	A P2 PC	2-year
21501Y	Yellow	Yellow	Super 21 Plug	Super 21 Plug	.180 Bullet	12	0.33	1	A P2 PC	2-year

PARTS INCLUDED IN KITS ABOVE

KIT #	Included Parts
21002R	21201R light, 96930 plug

KIT #	Included Parts
21002Y	21201Y light, 96930 plug

SUPER 21 SERIES

SUPER 21® SERIES, INCANDESCENT, 2 SCREW, KIT, REFLECTORIZED, SELF-PIERCING PLUG

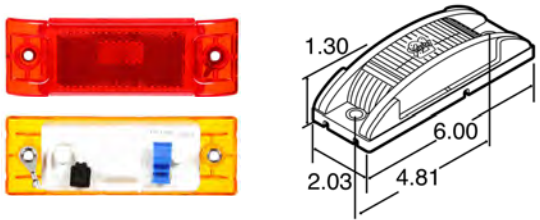

- Available with standard or reflectorized lens.
- Suitable for PC requirements on a 45-degree angle with additional reflectors.
- Version available for ABS requirements.
- Optional gaskets available to improve seal between lamp and body.
- Kits with extension brackets are a direct replacement for Utility Trailer #03-5100-0-097/8

Part Number	Lens Color	Mount Color	Lamp Connector	Volts	Amps	Bulbs	Lighting Codes	Warranty	Included Parts
21507R	Red	Red	Self-Piercing Plug	12	0.33	1	A P2	2-year	21201R light
21507Y	Yellow	Yellow	Self-Piercing Plug	12	0.33	1	A P2	2-year	21201Y light

INCANDESCENT

25 SERIES

25® SERIES, INCANDESCENT, 2 SCREW

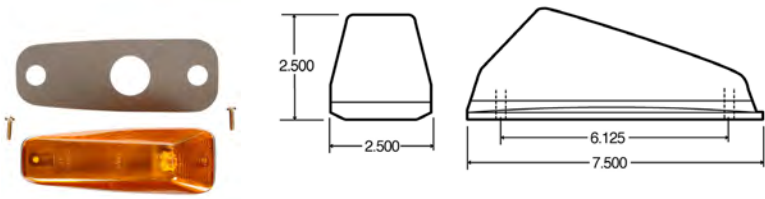

- Features surface mount design for replacement on many Ford trucks
- Contains #94940 plug assembly and one #194 wedge base bulb
- Lens and housing are sonically sealed
- Suitable for PC requirements on a 45-angle
- Replaces Signal-Stat 1360A

Part Number	Lens Color	Mount Color	Lamp Connector	Plug Side 1	Plug Side 2	Volts	Amps	Bulbs	Lighting Codes	Warranty
25760Y	Yellow	Gray	Socket Assembly	Socket Assembly	Ring Terminal/ Stripped End	12	0.27	1	P2 PC	1-year
25761Y	Yellow	Gray	Socket Assembly	Socket Assembly	Ring Terminal/ Stripped End	12	0.27	1	P2 PC	1-year
25780R	Red	Black	Socket Assembly	Socket Assembly	2 Position .180 Bullet Terminal	12	0.27	1	P2 PC	1-year

25[®] SERIES, INCANDESCENT, 2 STUD MOUNT

- Aerodynamic design for replacement on Ford trucks #F81B-15442-A
- Screw on polycarbonate lens and housing
- Mounts on 1-3/4" centers with foam gasket seal and M5 mounting studs
- Suitable for PC requirements on a 45-degree angle

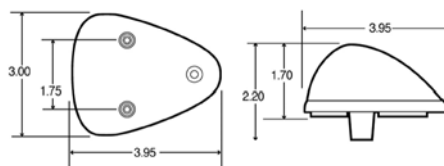

Part Number	Lens Color	Lamp Connector	Volts	Amps	Bulbs	Lighting Codes	Warranty
25762Y	Yellow	AMP 174928-1	12	0.27	1	P2 PC	1-year

INCANDESCENT

25 SERIES

25[®] SERIES, INCANDESCENT, 2 STUD MOUNT, KIT



- Aerodynamic design for replacement on Ford trucks #F81B-15442-A
- Screw-on polycarbonate lens and housing
- Mounts on 1-3/4" centers with foam gasket seal and M5 mounting studs
- Kit includes #95119 plug assembly to connect socket (mating to AMP 174928-1)
- Suitable for PC requirements on a 45-degree angle

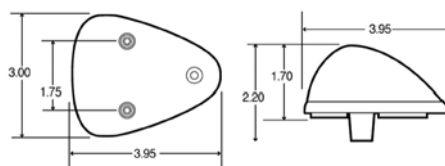

Part Number	Lens Color	Lamp Connector	Plug Side 1	Plug Side 2	Volts	Amps	Bulbs	Lighting Codes	Warranty
25062Y	Yellow	AMP 174921-1	AMP 174928-1	Stripped End	12	0.27	1	P2 PC	1-year

INCANDESCENT

25 SERIES

PARTS INCLUDED IN KITS ABOVE

KIT #	Included Parts
25062Y	25762Y light, 95119 plug

25[®] SERIES, LED, 2 SCREW, REFLECTORIZED, SOCKET ASSEMBLY

- Features surface-mount design for replacement on Mack trucks
- Sonically sealed lens and housing
- Mounting gasket included to improve seal of lamp and body
- Recommend Truck-Lite's #94940 plug and #194 bulb
- Not suitable for PC requirements
- Upgrade to LED using part #25250R/Y

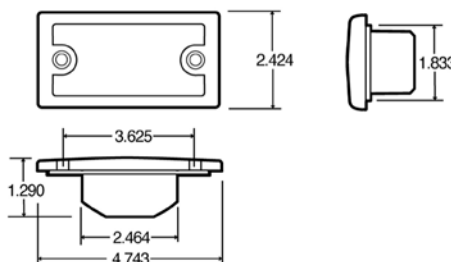

Part Number	Lens Color	Mount Color	Lamp Connector	Lighting Codes	Warranty
25765Y	Yellow	Yellow	Socket Assembly	A P2 PC	1-year
25766R	Red	Red	Socket Assembly	A P2 PC	1-year
25766Y	Yellow	Yellow	Socket Assembly	A P2 PC	1-year

INCANDESCENT

25 SERIES

26 SERIES, INCANDESCENT, BRACKET MOUNT, KIT



- Surface mounts on two screws at 1.5" centers
- Ground-through base
- Popular for use on school and commercial buses
- Heavy-duty steel and acrylic construction
- Lens attaches to base with one center screw
- Optional zinc-plated steel guard provides additional protection



Part Number	Lens Color	Mount Color	Lamp Connector	Plug Side 1	Plug Side 2	Volts	Amps	Bulbs	Lighting Codes	Warranty
26311R	Red	Silver	Hardwired	Hardwired	Stripped End	12	0.35	1	P2 PC	1-year
26311Y	Yellow	Silver	Hardwired	Hardwired	Stripped End	12	0.35	1	P2 PC	1-year
26313R	Red	Silver	Hardwired	Hardwired	Stripped End	12	0.35	2	P2 PC	1-year
26313Y	Yellow	Silver	Hardwired	Hardwired	Stripped End	12	0.35	2	P2 PC	1-year
26315R	Red	Silver	Hardwired	Hardwired	Stripped End	12	0.27	1	P2 PC	1-year
26315Y	Yellow	Silver	Hardwired	Hardwired	Stripped End	12	0.27	1	P2 PC	1-year
26353R	Red		Hardwired	Hardwired	Stripped End	12	0.35	1	P2 PC	3-year
26353Y	Yellow		Hardwired	Hardwired	Stripped End	12	0.35	1	P2 PC	3-year

PARTS INCLUDED IN KITS ABOVE

KIT #	Included Parts	KIT #	Included Parts
26311R	99160r lens	26315R	8930 lens
26311Y	99160y lens	26315Y	8930a lens
26313R	99160r lens	26353R	99170r lens
26313Y	99160y lens	26353Y	99170y lens

26 SERIES, INCANDESCENT, 2 SCREW, BEEHIVE

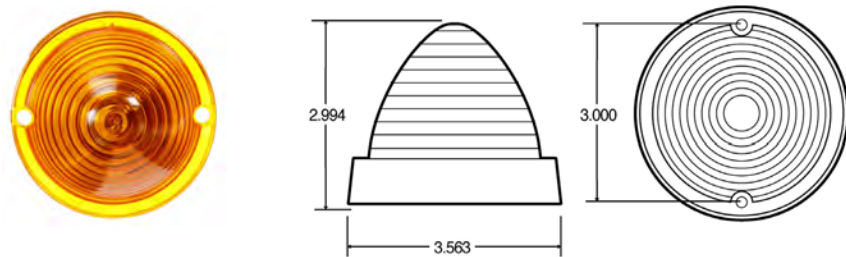

- Features a beehive lens designed for cab marker use
- Lens and housing are sonically sealed
- High impact polycarbonate construction

Part Number	Lens Color	Lamp Connector	Volts	Amps	Bulbs	Lighting Codes	Warranty
26762Y	Yellow	PL-10	12	0.33	1	P2 PC	1-year

26 SERIES, INCANDESCENT, 2 SCREW, KIT, BEEHIVE



- Features chrome-plated plastic housing with contour base and rubber mounting pad
- Includes one #67 bulb

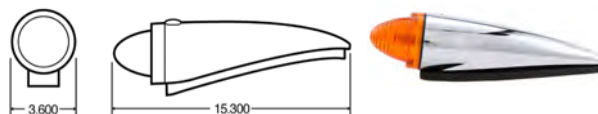

Part Number	Lens Color	Mount Color	Lamp Connector	Plug Side 1	Plug Side 2	Volts	Amps	Bulbs	Lighting Codes	Warranty
26760Y	Yellow	Silver	Hardwired	Hardwired	Ring Terminal/ Stripped End	12	0.35	1	P2 PC	1-year

PARTS INCLUDED IN KITS ABOVE

KIT #	Included Parts
26760Y	99066Y lens, 97046 pad, 97905 grommet

26 SERIES, INCANDESCENT, 2 SCREW, OVAL

- Innovative lamp design allows one lamp the ability to function as two
- Lamp is designed to comply with SAE J2042 requirements when mounted both horizontally and vertically
- Newly designed wire grommet provides improved water resistance between the lamp and wiring
- Polycarbonate lens offers added impact and heat resistance

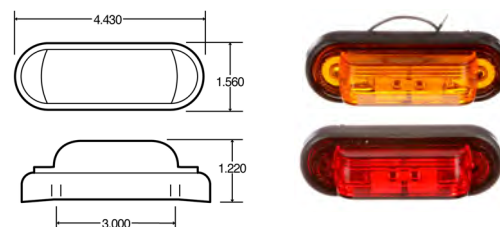

Part Number	Lens Color	Mount Color	Lamp Connector	Plug Side 1	Plug Side 2	Volts	Amps	Bulbs	Lighting Codes	Warranty
26901Y	Yellow		Hardwired	Hardwired	.180 Bullet	12	0.5	2	P2 P3 PC	1-year
26310R	Red	Black	Hardwired	Hardwired	Stripped End	12	0.27	2	P2 PC	1-year
26310Y	Yellow	Black	Hardwired	Hardwired	Stripped End	12	0.27	2	P2 PC	1-year
26312R	Red	Red	Hardwired	Hardwired	Stripped End	12	0.27	2	P2 PC	1-year
26312Y	Yellow	Yellow	Hardwired	Hardwired	Stripped End	12	0.27	2	P2 PC	1-year

26 SERIES, INCANDESCENT, 2 SCREW, RECTANGULAR

- High-impact Permastat housing protects against rust and corrosion
- Shock/Mount (1213 model) for maximum bulb life
- Snap-on lens makes bulb and lens replacement easy
- Two bulb design-if one burns out, the other remains lighted
- Lamp meets requirements with only one bulb
- Not suitable for PC requirements
- Replaces Truck-Lite 26302 series

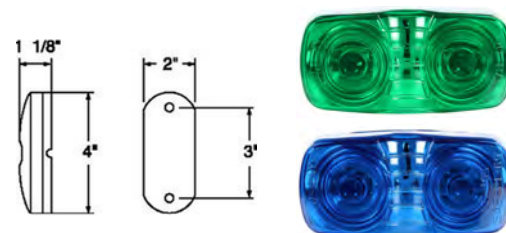

Part Number	Lens Color	Lamp Connector	Plug Side 1	Plug Side 2	Volts	Amps	Bulbs	Warranty
26302B	Blue	Hardwired	Hardwired	Stripped End	12	0.27	2	1-year
26302G	Green	Hardwired	Hardwired	Stripped End	12	0.27	2	1-year

INCANDESCENT

26 SERIES

INCANDESCENT

26 SERIES

26 SERIES, INCANDESCENT, 2 SCREW, ROUND

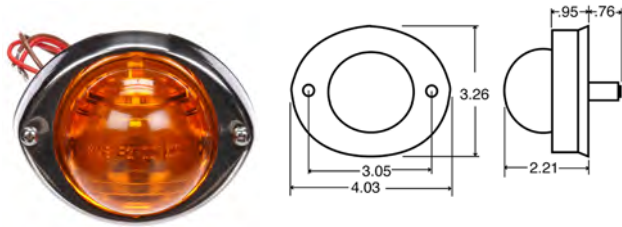

- Popular in bus applications
- Provide marker and auxiliary side-turn indicator functions
- Features stainless steel and two holes for #10 screws on 1.625" centers
- Clearance hole of .812 diameter required

Part Number	Lens Color	Mount Color	Lamp Connector	Plug Side 1	Plug Side 2	Volts	Amps	Bulbs	Lighting Codes	Warranty
26390Y	Yellow	Silver	Hardwired	Hardwired	Stripped End	12	0.27	1	P2	1-year

26 SERIES, INCANDESCENT, 2 SCREW, TRIANGLE

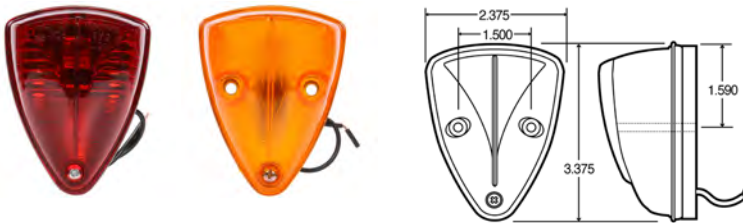

- Surface mounts on two pass-through lens screws at 1.5" centers
- Ground-through base
- Popular for use on school buses and commercial vehicles
- Heavy-duty steel and acrylic construction
- Lens attaches to base with one screw
- Optional zinc-plated steel guard provides additional protection

Part Number	Lens Color	Mount Color	Lamp Connector	Plug Side 1	Plug Side 2	Volts	Amps	Bulbs	Lighting Codes	Warranty
26771Y	Yellow	Black	Hardwired	Hardwired	Stripped End	12	0.69	1	P2 PC	1-year
26354R	Red	Silver	Hardwired	Hardwired	Stripped End	12	0.69	1	P2 PC	1-year
26354Y	Yellow	Steel	Hardwired	Hardwired	Stripped End	12	0.69	1	P2 PC	1-year
26765R	Red	Black	Socket Assembly	Socket Assembly	Stripped End	12	0.59	1	P2 PC	1-year
26765Y	Yellow	Black	Socket Assembly	Socket Assembly	Stripped End	12	0.59	1	P2 PC	1-year
26771R	Red	Black	Hardwired	Hardwired	Stripped End	12	0.69	1	P2 PC	1-year

26 SERIES, INCANDESCENT, BRACKET MOUNT, OVAL

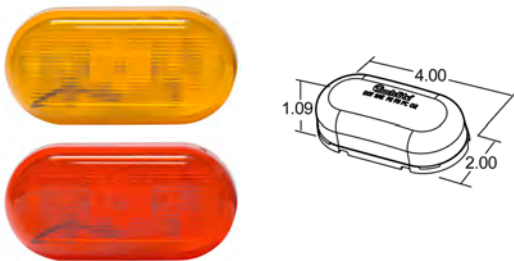

- Innovative lamp design allows one lamp the ability to function as two
- Lamp is designed to comply with SAE J2042 requirements when mounted both horizontally and vertically
- Newly designed wire grommet provides improved water resistance between the lamp and wiring
- Polycarbonate lens offers added impact and heat resistance

Part Number	Lens Color	Mount Color	Lamp Connector	Plug Side 1	Plug Side 2	Volts	Amps	Bulbs	Lighting Codes	Warranty
26901R	Red	White	Hardwired	Hardwired	.180 Bullet	12	0.5	2	P2 P3 PC	1-year
26902R	Red	White	Hardwired	Hardwired	.180 Bullet	12	0.5	2	P2 P3 PC	1-year
26902Y	Yellow		Hardwired	Hardwired	.180 Bullet	12	0.5	2	P2 P3 PC	1-year

30[®] SERIES, INCANDESCENT, GROMMET MOUNT

- Wabash and Monon replacement
- “ABS” version complies with FMVSS 108 requirement for ABS malfunction indicator lamp on trailer and ABS braking systems
- 12 volt, 15,000-hour-rated bulb life
- Lamp designed for PC requirements on a 45-degree angle in mounting devices #30720, #00801, #00803, #00804 or surface-mount flange

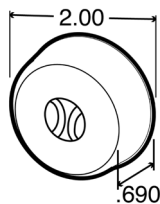

Part Number	Lens Color	Lamp Connector	Volts	Amps	Bulbs	Lighting Codes	Warranty
30200B	Blue	PL-10	12	0.33	1		1-year
30200G	Green	PL-10	12	0.33	1		1-year
30200R	Red	PL-10	12	0.33	1	P2 P3 PC	1-year
30200Y	Yellow	PL-10	12	0.33	1	P2 P3 PC	1-year
30204R	Red	PL-10	12	0.33	1	P2 PC	1-year
30204Y	Yellow	PL-10	12	0.33	1	P2 PC	1-year
30206G	Green	PL-10	24	0.17	1		1-year
30206R	Red	PL-10	24	0.17	1	P2 P3 PC	1-year
30206Y	Yellow	PL-10	24	0.17	1	P2 P3 PC	1-year
30230Y	Yellow	PL-10	12	0.33	1	P2 P3 PC	1-year
30257Y	Yellow	PL-10	12	0.33	1	P2 P3 PC	1-year

30[®] SERIES, INCANDESCENT, GROMMET MOUNT, KIT

- KIT**
- Wabash and Monon replacement
 - “ABS” version complies with FMVSS 108 requirement for ABS malfunction indicator lamp on trailer and ABS braking systems
 - 12 volt, 15,000-hour-rated bulb life
 - Lamp designed for PC requirements on a 45-degree angle in mounting devices #30720, #00801, #00803, #00804 or surface mount flange

AVAILABLE CONNECTORS

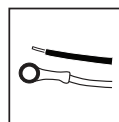

RING TERMINAL / STRIPPED END

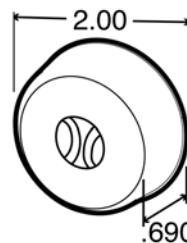

Part Number	Lens Color	Mount Color	Lamp Connector	Plug Side 1	Plug Side 2	Volts	Amps	Bulbs	Lighting Codes	Warranty
30503R	Red	Black	PL-10	PL-10	Ring Terminal/Stripped End	12	0.33	1	P2 P3 PC	1-year
30503Y	Yellow	Black	PL-10	PL-10	Ring Terminal/Stripped End	12	0.33	1	P2 P3 PC	1-year

PARTS INCLUDED IN KITS ABOVE

KIT #	Included Parts
30503R	30200R light, 30700 grommet, 94902 plug
30503Y	30200Y light, 30700 grommet, 94902 plug

INCANDESCENT

30 SERIES

INCANDESCENT

30 SERIES

30[®] SERIES, INCANDESCENT, BRACKET MOUNT, KIT

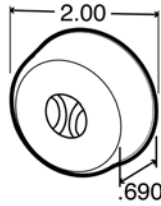

AVAILABLE CONNECTORS

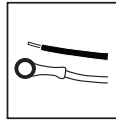

RING TERMINAL
/ STRIPPED END

- Rust-resistant stainless steel mount
- Quick cam-on, cam-off lamp installation
- Meets PC requirements on a 45-degree angle
- Mounts with screws to surface, not included
- Not recommended for Signal-Stat LED lamps



Part Number	Lens Color	Mount Color	Lamp Connector	Plug Side 1	Plug Side 2	Volts	Amps	Bulbs	Lighting Codes	Warranty
30001R	Red	Silver	PL-10	PL-10	Stripped End/ Ring Terminal	12	0.33	1	P2 PC	1-year
30001Y	Yellow	Silver	PL-10	PL-10	Stripped End/ Ring Terminal	12	0.33	1	P2 PC	1-year
30504R	Red	Gray	PL-10	PL-10	Ring Terminal/ Stripped End	12	0.33	1	P2 P3 PC	1-year
30504Y	Yellow	Gray	PL-10	PL-10	Ring Terminal/ Stripped End	12	0.33	1	P2 P3 PC	1-year

PARTS INCLUDED IN KITS ABOVE

KIT #	Included Parts
30001R	30200R light, 30720 bracket, 94902 plug
30001Y	30200Y light, 30720 bracket, 94902 plug
30504R	30200R light, 30701 grommet, 30722 bracket, 94902 plug
30504Y	30200Y light, 30701 grommet, 30722 bracket, 94902 plug

30[®] SERIES, INCANDESCENT, FLANGE MOUNT



- Innovative design allows one lamp the ability to function as two
- 12 volt, 15,000-hour-rated bulb
- Lamp designed for PC requirements on a 45-degree angle in grommet mounting devices #30700, #30702, #30704, #30706 and #30707

Part Number	Lens Color	Mount Color	Lamp Connector	Volts	Amps	Bulbs	Lighting Codes	Warranty
30222R	Red	Gray	PL-10	12	0.33	1	P2 PC	1-year
30222Y	Yellow	Gray	PL-10	12	0.33	1	P2 PC	1-year
30223R	Red	Gray	PL-10	12	0.33	1	P2 P3 PC	1-year
30223Y	Yellow	Gray	PL-10	12	0.33	1	P2 P3 PC	1-year

30[®] SERIES, INCANDESCENT, FLUSH MOUNT

- Flanges are permanently affixed to lamp
- 12 volt, 15,000-hour-rated bulb
- Flush mount is not suitable for PC requirements

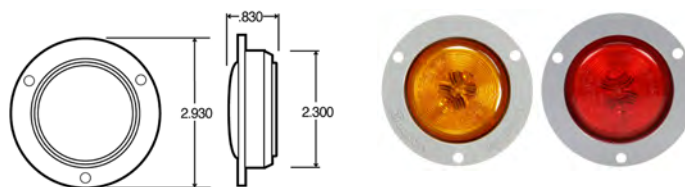

Part Number	Lens Color	Mount Color	Lamp Connector	Volts	Amps	Bulbs	Lighting Codes	Warranty
30221R	Red	Gray	PL-10	12	0.33	1	P2	1-year
30221Y	Yellow	Gray	PL-10	12	0.33	1	P2	1-year

INCANDESCENT

30 SERIES

30[®] SERIES, INCANDESCENT, GROMMET MOUNT, BEEHIVE

- Features a beehive lens designed for cab marker use
- Lens and housing are sonically sealed
- High impact polycarbonate construction
- 12, volt 15,000-hour-rated bulb
- Suitable for PC requirements on a 45 angle

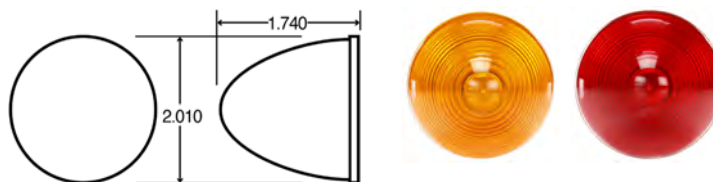

Part Number	Lens Color	Lamp Connector	Volts	Amps	Bulbs	Lighting Codes	Warranty
30201R	Red	PL-10	12	0.33	1	P2 PC	LIFETIME
30201Y	Yellow	PL-10	12	0.33	1	P2 PC	LIFETIME

INCANDESCENT

30 SERIES

60[®] SERIES, INCANDESCENT, GROMMET MOUNT, REFLECTORIZED

- Features a beehive lens designed for cab marker use
- Lens and housing are sonically sealed
- High-impact polycarbonate construction
- 12 volt, 15,000-hour-rated bulb
- Suitable for PC requirements on a 45-angle

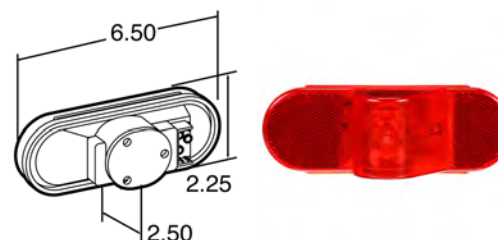

Part Number	Lens Color	Lamp Connector	Volts	Amps	Bulbs	Lighting Codes	Warranty
60215R	Red	PL-3	12	0.49/2.1	1	A P2	1-year

INCANDESCENT

60 SERIES

IDENTIFICATION BARS

LED LIGHTS

Pages 166-168

SERIES	PAGES
15® Series	166
33® Series	166
35® Series	167-168

INCANDESCENT LIGHTS

Pages 169-171

SERIES	PAGES
10® Series	169
15® Series	169
26 Series	170
30® Series	170
Signal-Stat	171

15[®] SERIES, LED, ID LIGHT ASSEMBLY, GROMMET MOUNT, KIT



RED



YELLOW

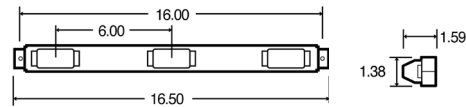

- Designed to fit applications requiring minimal space
- Features stainless steel bar with three LED Model 15 lamps on 6" centers
- Electronics completely sealed in epoxy to resist corrosion and moisture
- Sonically sealed lens and housing
- Less susceptible to shock and vibration
- Draws less current, allowing more power for other vehicle requirements
- Direct pin-to-circuit board solders assure vibration-resistant contacts

Standards Met
P2



Part Number	Lens Color	Lamp Connector	Plug Side 1	Plug Side 2	Volts	Diodes	Mount Color	Center Distance	Kit Includes
15050R	Red	PL-10	PL-10	.180 Bullet/Ring Terminal	12	1	Silver	6in	15250R light, 00808 bar, 93943 harness
15050Y	Yellow	PL-10	PL-10	.180 Bullet/Ring Terminal	12	3	Silver	6in	15250Y light, 00808 bar, 93943 harness

33[®] SERIES, LED, ID LIGHT ASSEMBLY, GROMMET MOUNT

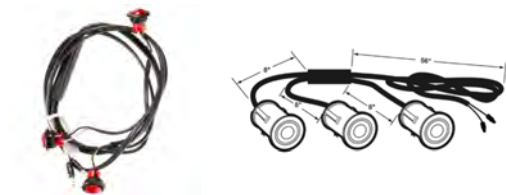

- US patent #6612728
- World smallest LED marker lamp for the transportation industry
- Hardwired lamp design is easily retrofitted
- Requires 3/4" mounting hole



Standards Met
P2

Part Number	Lens Color	Lamp Connector	Plug Side 1	Plug Side 2	Volts	Amps Major/Minor	Diodes	Mount Color
33740R	Red	Hardwired	Hardwired	.180 Bullet	12	0.05	1	Black
33751R	Red	Hardwired	Hardwired	.180 Bullet/Female .180 Bullet	12	0.05	1	Black

Keep Your Connections Safe. Don't Forget Your Dielectric Gel.

Dielectric gel protects your lights by protecting the points of contact between elements of your lighting and harness system. Our dielectric compounds prevent arcing and corrosion and keep your lights performing as they should.

You can find our dielectric products on page 498



35[®] SERIES, LED, ID LIGHT ASSEMBLY, GROMMET MOUNT, KIT

Standards Met

P2|P3

- Designed to fit applications requiring minimal space
- Slim 1" width is perfect for upper rail mounting
- Draws less current, allowing more power for other vehicle requirements

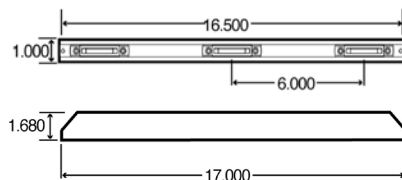

15050R



15050Y

Part Number	Lens Color	Lamp Connector	Plug Side 1	Plug Side 2	Volts	Diodes	Mount Color	Center Distance	Kit Includes
35740R	Red	Fit 'N Forget M/C	Fit 'N Forget M/C	.180 Bullet/Ring Terminal	12	1	Silver	6in	35200R light, 00815 bar, 96989 harness
35740Y	Yellow	Fit 'N Forget M/C	Fit 'N Forget M/C	.180 Bullet/Ring Terminal	12	3	Silver	6in	35200Y light, 00815 bar, 96989 harness
35741R	Red	Fit 'N Forget M/C	Fit 'N Forget M/C	.180 Bullet/Ring Terminal	12	1	Silver	9in	35200R light, 00816 bar, 96996 harness
35741Y	Yellow	Fit 'N Forget M/C	Fit 'N Forget M/C	.180 Bullet/Ring Terminal	12	3	Silver	9in	35200Y light, 00816 bar, 96996 harness

35[®] SERIES, LED, DUAL FUNCTION, ID LIGHT ASSEMBLY, BRACKET MOUNT, 3 LIGHTS, KIT

Standards Met

P2|PC



- Allows marker and clearance lamps to operate in two output levels
- Brighter lighting activated by the brake function
- Great for retrofitting existing lighting systems
- Provides added safety benefit to trailing drivers with additional braking awareness at a higher level on the vehicle notifying drivers more quickly of vehicle stops
- Internal electronics protect vehicle from electrical feedback
- Heavy-duty design allows for carefree maintenance

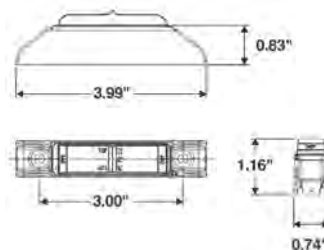

Part Number	Lens Color	Lamp Connector	Plug Side 1	Plug Side 2	Volts	Diodes	Mount Color	Kit Includes
35033R	Red	Fit 'N Forget M/C	No Plug	No Plug	12	5	Red	35200R light, 00815 bar, 96989 harness
35035R	Red	Fit 'N Forget M/C	No Plug	No Plug	12	5	Red	35200R light, 00816 bar, 96996 harness

35[®] SERIES, LED, DUAL FUNCTION, ID LIGHT ASSEMBLY, BRACKET MOUNT, KIT, 5 LIGHTS

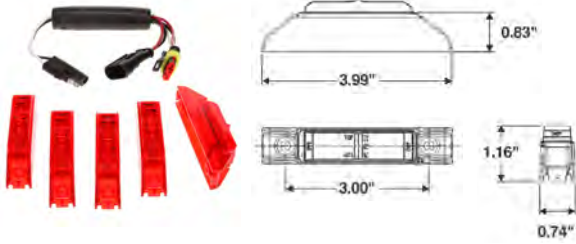

- Allows marker and clearance lamps to operate in two output levels
- Brighter lighting activated by the brake function
- Great for retrofitting existing lighting systems
- Provides added safety benefit to trailing drivers with additional braking awareness at a higher level on the vehicle notifying drivers more quickly of vehicle stops
- Internal electronics protect vehicle from electrical feedback
- Heavy-duty design allows for carefree maintenance

Standards Met

P2|PC



Part Number	Lens Color	Lamp Connector	Plug Side 1	Plug Side 2	Volts	Diodes	Mount Color	Kit Includes
35034R	Red	Fit 'N Forget M/C	No Plug	No Plug	12	5	Red	35200Y light, 00815 bar, 96989 harness
35036R	Red	Fit 'N Forget M/C	No Plug	No Plug	12	5	Red	35200Y light, 00816 bar, 96996 harness



Quick Tip: Plug Side 1 vs. Plug Side 2

When buying a plug for your light it's important to understand what type of connection mates with the light and what type of termination will mate with the power harness. Plug Side 1 refers to the side of the plug that mates directly to the light. Plug Side 2 refers to the end of the plug that will mate with the power source.



Keep Your Connections Safe. Don't Forget Your Dielectric Gel.

Dielectric gel protects your lights by protecting the points of contact between elements of your lighting and harness system. Our dielectric compounds prevent arcing and corrosion and keep your lights performing as they should.

You can find our dielectric products on page 498



10[®] SERIES, INCANDESCENT, 4 SCREW BRACKET MOUNT, KIT

Standards Met

P2

- Features rugged stainless steel or black enameled ID bar
- Lamps are mounted on 6" or 9" centers

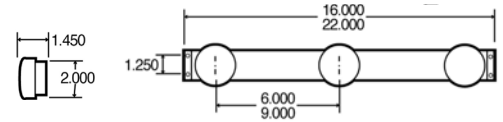

Part Number	Lens Color	Lamp Connector	Plug Side 1	Plug Side 2	Volts	Bulbs	Mount Color	Center Distance	Kit Includes
10744R	Red	PL-10	PL-10	Stripped End/Ring Terminal	12	1	Black	6in	35200R light, 00815 bar, 96989 harness
10745R	Red	PL-10	PL-10	Stripped End/Ring Terminal	12	1	Black	9in	10202R light, 00798 bar, 93906 harness

15[®] SERIES, INCANDESCENT, 4 SCREW BRACKET MOUNT, KIT

Standards Met

P2

- Features rugged stainless steel ID bar designed to fit in limited mounting areas
- Lamps are mounted on 6" centers
- Direct replacement for Ford
- Fits in most narrow header rails
- Snap-lock tabs allow easy installation



RED



YELLOW

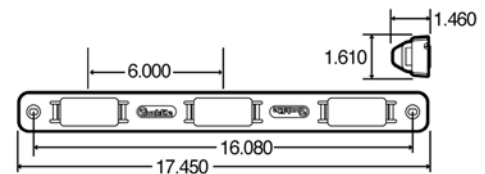

Part Number	Lens Color	Lamp Connector	Plug Side 1	Plug Side 2	Volts	Bulbs	Mount Color	Center Distance	Kit Includes
15741R	Red	PL-10	PL-10	.180 Bullet/Ring Terminal	12	1	Silver	6in	15200R light, 00808 bar, 93943 harness
15745R	Red	PL-10	PL-10	Stripped End	12	1	Black	6in	10202R light, 00798 bar, 93906 harness
15745Y	Yellow	PL-10	PL-10	Stripped End	12	1	Black	6in	15200Y light, 00817 bar, 93945 harness

26 SERIES, INCANDESCENT, 4 SCREW BRACKET MOUNT, KIT, BEEHIVE



- Features zinc-plated steel bar in either 15" or 20" lengths
- Bar contains three lamps with #67 bulb and lens retention snap ring

Standards Met

P2

KIT

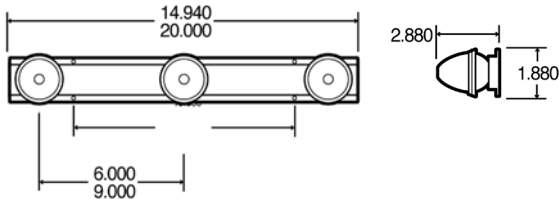

Part Number	Lens Color	Lamp Connector	Plug Side 1	Plug Side 2	Volts	Bulbs	Mount Color	Center Distance	Kit Includes
26740R	Red	Hardwired	Hardwired	Stripped End	12	1	Silver	9in	9004 light, 97947 snap ring
26741R	Red	Hardwired	Hardwired	Stripped End	12	1	Silver	6in	9004 light, 97947 snap ring

30[®] SERIES, INCANDESCENT, 4 SCREW BRACKET MOUNT, KIT



- Features rugged stainless steel or black enameled ID bar
- Lamps are mounted on 6" or 9" centers

Standards Met

P2

KIT

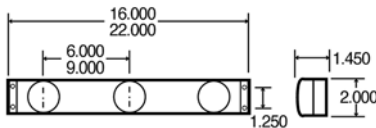

Part Number	Lens Color	Lamp Connector	Plug Side 1	Plug Side 2	Volts	Bulbs	Mount Color	Center Distance	Kit Includes
30740R	Red	PL-10	PL-10	Stripped End/ Ring Terminal	12	1	Black	6in	30200R light, 00798 bar, 93906 harness
30742R	Red	PL-10	PL-10	Stripped End/ Ring Terminal	12	1	Black	9in	35200Y light, 00816 bar, 96996 harness

SIGNAL-STAT, INCANDESCENT, 1" X 2", 2 SCREW BRACKET MOUNT, KIT



Standards Met

P2

- Popular economy identification bar for light duty applications
- Acrylic lens and housing
- Coated polycarbonate bar

KIT

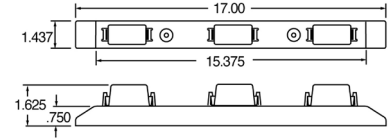

Part Number	Lens Color	Lamp Connector	Plug Side 1	Plug Side 2	Volts	Bulbs	Mount Color	Kit Includes
1508R	Red	Hardwired	Hardwired	Stripped End/ Ring Terminal	12	1	White	35200R light, 00815 bar 96989 harness

INCANDESCENT

SIGNAL-STAT

SIGNAL-STAT, INCANDESCENT, 2" X 4", BRACKET MOUNT, KIT



Standards Met

P2|PC

- Popular economy identification bar for light duty applications
- Acrylic lens and housing
- Coated polycarbonate bar

KIT



RED



AMBER

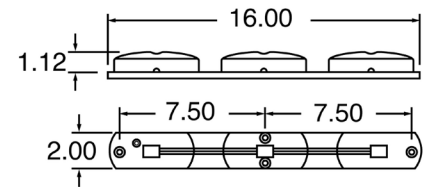

Part Number	Lens Color	Lamp Connector	Plug Side 1	Plug Side 2	Volts	Bulbs	Mount Color	Kit Includes
1215	Red	Hardwired	Hardwired	Stripped End	12	2	Black	35200R light, 00815 bar 96989 harness
1216	Red	Hardwired	Hardwired	Stripped End	12	2	White	35200R light, 00815 bar 96989 harness
1216A	Amber	Hardwired	Hardwired	Stripped End	12	2	White	35200R light, 00815 bar 96989 harness

INCANDESCENT

SIGNAL-STAT